

dipCore32

A reduced Core for your MIDIbox App, an STM32F405RG on a DIP40 board size.



Features

- MIOS32 uses same processor family and drivers(no deep change).
- Same internal hardware as Disco or wCore (speed, memory, peripherals, etc...) .
- Board pinout and package compatible with a MIOS8 PIC 😎
- USB connector onboard.
- 5V power input and led.
- 3.3V regulator and led on board.
- 74HCT541 on board for the 5V output ports.
- User and Reset buttons.
- 2 user leds.
- 8 extra pins for USB, buttons and leds.
- Your favorite Core is now a current component easy to integrate.

All commons MIOS32 ports are available except:

- General purpose J10x ports were removed.
- LCD port was reduced to a serial one, no more pins J15.D0-D7
- 2 UART only(2 MIDI In/2Out).
- 2 AIN channels only(e.g. pedal inputs)

Check the [dipBoard](#) for more details



PCB

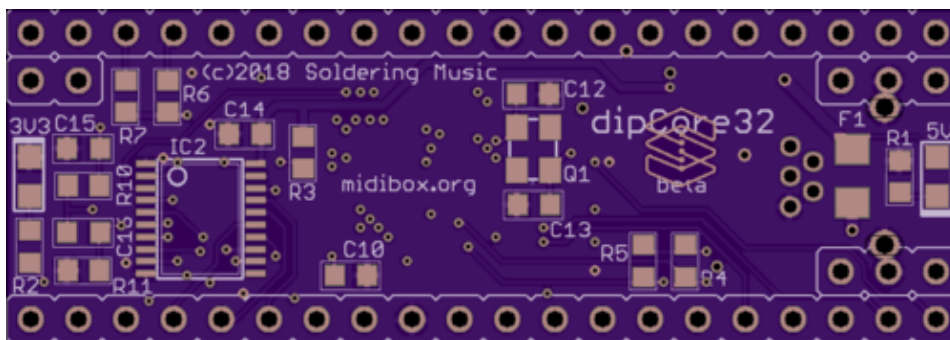
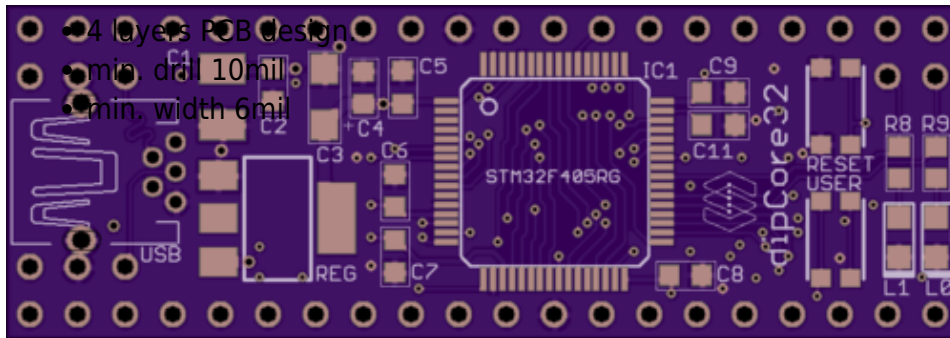

Top copper

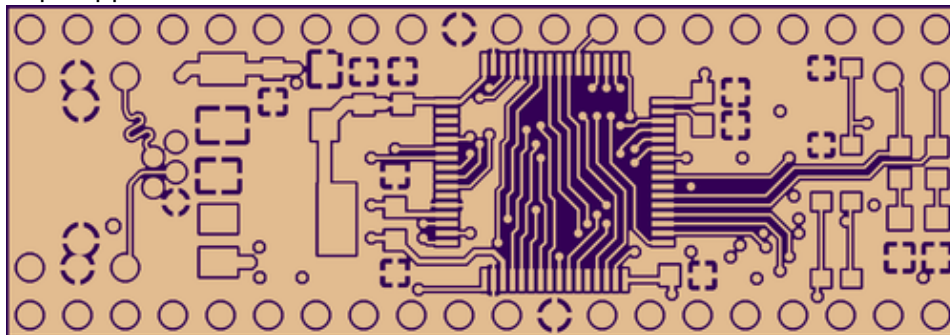

Internal 1

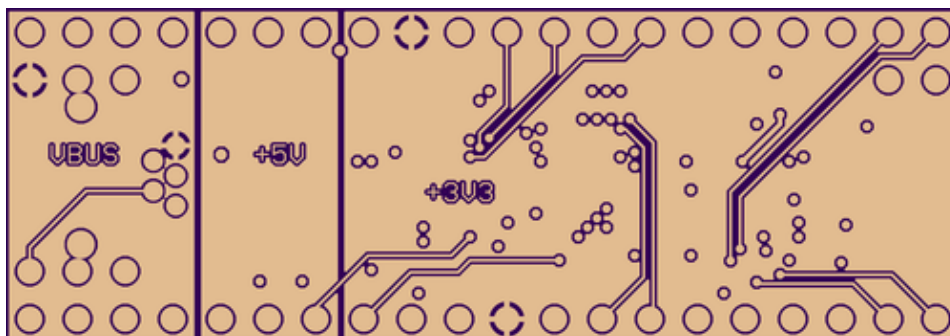

Internal 2

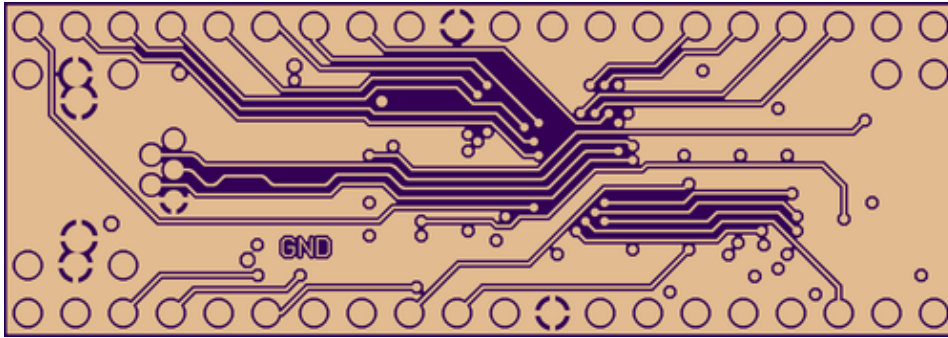

Bottom

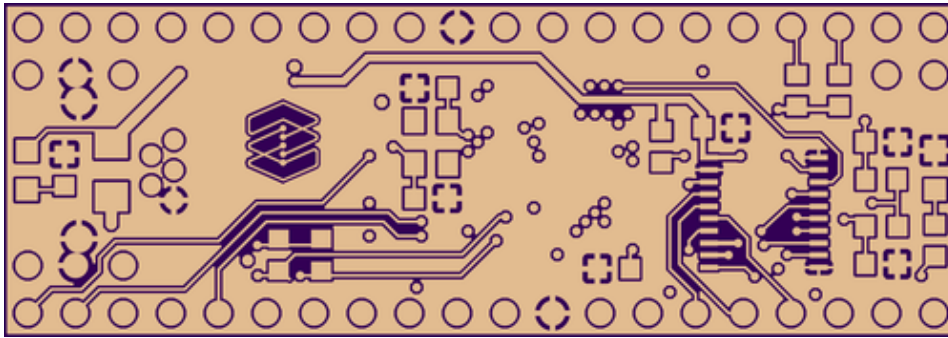

Pinout

| PIC / MIO8 | | STM32F4 / MIO32 | | | | | | | | |
|------------|---------------|-----------------|--------|----------------|----------------|---------|--------------------|----------|----------------------|------|
| DIP40 | MIO8 Function | dipCoreF4 | | | DISCO / wCore | | | Pin name | | |
| | | DIP40 | LQFP64 | STM32 F415RG | MIO32 Function | LQFP100 | STM32F 407VG | | Discovery F4 Pin | |
| 2 | J5 RA0 | 2 | 14 | GPIO | USER BUTT | 23 | USER BUTT | P1.12 | PA0(s)-WKUP(s) | |
| 3 | J5 RA1 | 3 | 58 | I2C1_SCL | J4B.SC | 92 | I2C1_SCL | P2.23 | PB6 | |
| 4 | J5 RA2 | 4 | 59 | I2C1_SDA | J4B.SD | 93 | USART1_RX | P2.24 | PB7 | |
| 5 | J5 RA3 | 5 | 17 | USART2_RX | J11.MI1 | 26 | USART2_RX | P1.13 | PA3(s) | |
| 6 | J5 RA4 | 6 | 16 | USART2_TX | J11.MD1 | 25 | USART2_TX | P1.14 | PA2(s) | |
| 7 | J5 RA5 | 7 | 15 | ADC123_IN1 | J5.A0 | 24 | ADC123_IN1 | P1.11 | PA1(s) | |
| 8 | J5 RE0 | 8 | 25 | ADC12_IN15 | J5.A1 | 34 | ADC12_IN15 | P1.19 | PC5(s) | |
| 9 | J5 RE1 | 9 | 40 | SP3_RC2(GPIO) | J19.RC2 | 66 | LCD:SER/E2 | P2.46 | PC9 | |
| 10 | J5 RE2 | 10 | 26 | SPI2_RC2(GPIO) | J8/9.RC2 | 35 | ADC12_IN8 | P1.22 | PB0(s) | |
| 13 | OSC1 | 13 | 46 | JTMS-SWDIO | | 72 | JTMS-SWDIO | P2.42 | PA13 | |
| 14 | OSC2 | 14 | 49 | JTCK-SWCLK | | 76 | JTCK-SWCLK | P2.39 | PA14 | |
| 15 | J6/7_RC | 15 | 50 | SPI3_RC1(NSS) | J19.RC1 | 77 | SPI3_NSS:RC1 | P2.40 | PA15 | |
| 16 | J6/7_SC | 16 | 55 | SPI3_SCK | J19.SC | 89 | SPI3_SCK | P2.28 | PB3 | |
| 17 | J6/7_SO | 17 | 57 | SPI3_MOSI | J19.SO | 91 | SPI3_MOSI | P2.26 | PB5 | |
| 18 | J6/7_SI | 18 | 56 | SPI3_MISO | J19.SI | 90 | SPI3_MISO | P2.25 | PB4 | |
| 19 | J8/9 S0 | 19 | 11 | SPI2_MOSI | J8/9.SO | 18 | N.U. | P1.9 | PC3(s) | |
| 20 | J8/9 SI | 20 | 10 | SPI2_MISO | J8/9.SI | 17 | ADC123_IN12 | P1.10 | PC2(s) | |
| 21 | J8/9 RC | 21 | 27 | SPI2_RC1(GPIO) | J8/9.RC1 | 36 | ADC12_IN9 | P1.21 | PB1(s) | |
| 22 | J8/9 SC | J10 SC | 22 | 34 | SPI2_SCK | J8/9.SC | 52 | SPI2_SCK | P1.37 | PB13 |
| 23 | J10 RC | 23 | 30 | I2C2_SDA | J4A.SC | 48 | I2C2_SDA | P1.35 | PB11 | |
| 24 | J10 SO | 24 | 29 | I2C2_SCL | J4A.SD | 47 | I2C2_SCL | P1.34 | PB10 | |
| 25 | J11 TX | 25 | 51 | UART4_TX | J11.MD2 | 78 | DAC_CK(discovery) | P2.37 | PC10 | |
| 26 | J11 RX | 26 | 52 | UART4_RX | J11.MI2 | 79 | LCD:SER/R/W | P2.38 | PC11 | |
| 27 | J14 | 27 | 8 | GPIO | J15.CS2 | 15 | OTG_FS_EN | P1.8 | PC0(s) | |
| 28 | J15 RS | J10 MD | 28 | 54 | GPIO | J15.DC | 83 | UART5_RX | P2.34 | PD2 |
| 29 | J15 RW | J10 MD | 29 | 53 | GPIO | J15.SDA | 80 | UART5_TX | P2.35 | PC12 |
| 30 | J15 E | 30 | 9 | GPIO | J15.SCL | 16 | ADC123_IN11 | P1.7 | PC1(s) | |
| 33 | J15 D0 | 33 | 33 | GPIO | J15.CS1 | 51 | SPI2_NSS:RC1 | P1.36 | PB12 | |
| 34 | J15 D1 | 34 | 24 | SPI1_RC2(GPIO) | J16.RC2 | 33 | ADC12_IN14 | P1.20 | PC4(s) | |
| 35 | J15 D2 | 35 | 62 | CAN1_TX | J18.TX | 96 | I2C1_SDA | P2.20 | PB9 | |
| 36 | J15 D3 | 36 | 61 | CAN1_RX | J18.RX | 95 | SP3_RC2 | P2.19 | PB8 | |
| 37 | J15 D4 | 37 | 20 | SPI1_RC1(NSS) | J16.RC1 | 29 | ADC12_IN4 | P1.16 | PA4(s) | |
| 38 | J15 D5 | 38 | 21 | SPI1_SCK | J16.SC | 30 | SPI1_SCK | P1.15 | PA5(s) | |
| 39 | J15 D6 | 39 | 22 | SPI1_MISO | J16.SI | 32 | SPI1_MOSI | P1.17 | PA7(s) | |
| 40 | J15 D7 | 40 | 23 | SPI1_MOSI | J16.SO | 31 | SPI1_MISO | P1.18 | PA6(s) | |
| | | 41 | 43 | OTG_FS_ID | J1.D1 | 69 | OTG_FS_ID | P2.41 | PA10 | |
| | | 43 | 45 | OTG_FS_DP | J1.DP1 | 71 | OTG_FS_DP | CN5(USB) | PA12 | |
| | | 44 | 35 | OTG_HS_DM | J1.DM2 | 53 | SPI2_MISO | P1.38 | PB14 | |
| | | 45 | 36 | OTG_HS_DP | J1.DP2 | 54 | SPI2_MOSI | P1.39 | PB15 | |
| | | 46 | 42 | OTG_FS_VBUS | J1.VBUS | 68 | OTG_FS_VBUS | P2.44 | PA9 | |
| | | 48 | 44 | OTG_FS_DM | J1.DM1 | 70 | OTG_FS_DM | CN5(USB) | PA11 | |
| | | 49 | 3 | OTG_HS_OC | J1.OC2 | 8 | J10/D9 | P2.9 | PC14(s)-OSC32_IN(s) | |
| | | 50 | 4 | OTG_HS_EN | J1.EN2 | 9 | J10/D10 | P2.10 | PC15(s)-OSC32_OUT(s) | |
| | | 51 | 38 | LED BLUE | LED.2 | 64 | DAC_MCK(discovery) | P2.48 | PC7 | |
| | | 52 | 37 | LED RED | LED.1 | 63 | USART6_TX | P2.47 | PC6 | |
| | | 2 | | N.U. | | 7 | J10/D8 | P2.12 | PC13(s) | |
| | | 5 | | OSC_IN | | 12 | N.U. | P2.7 | PH0(s)-OSC_IN | |
| | | 6 | | OSC_OUT | | 13 | N.U. | P2.8 | PH1(s)-OSC_OUT | |
| | | 28 | | N.U. | | 37 | SPI1_RC1 | P1.24 | PB2 | |
| | | 39 | | N.U. | | 65 | LCD:SER/E1 | P2.45 | PC8 | |
| | | 41 | | N.U. | | 67 | LCD:RS | P2.43 | PA8 | |

full

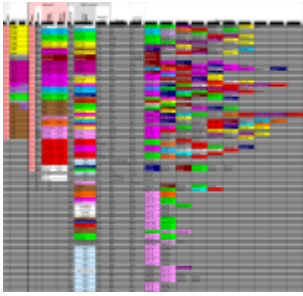
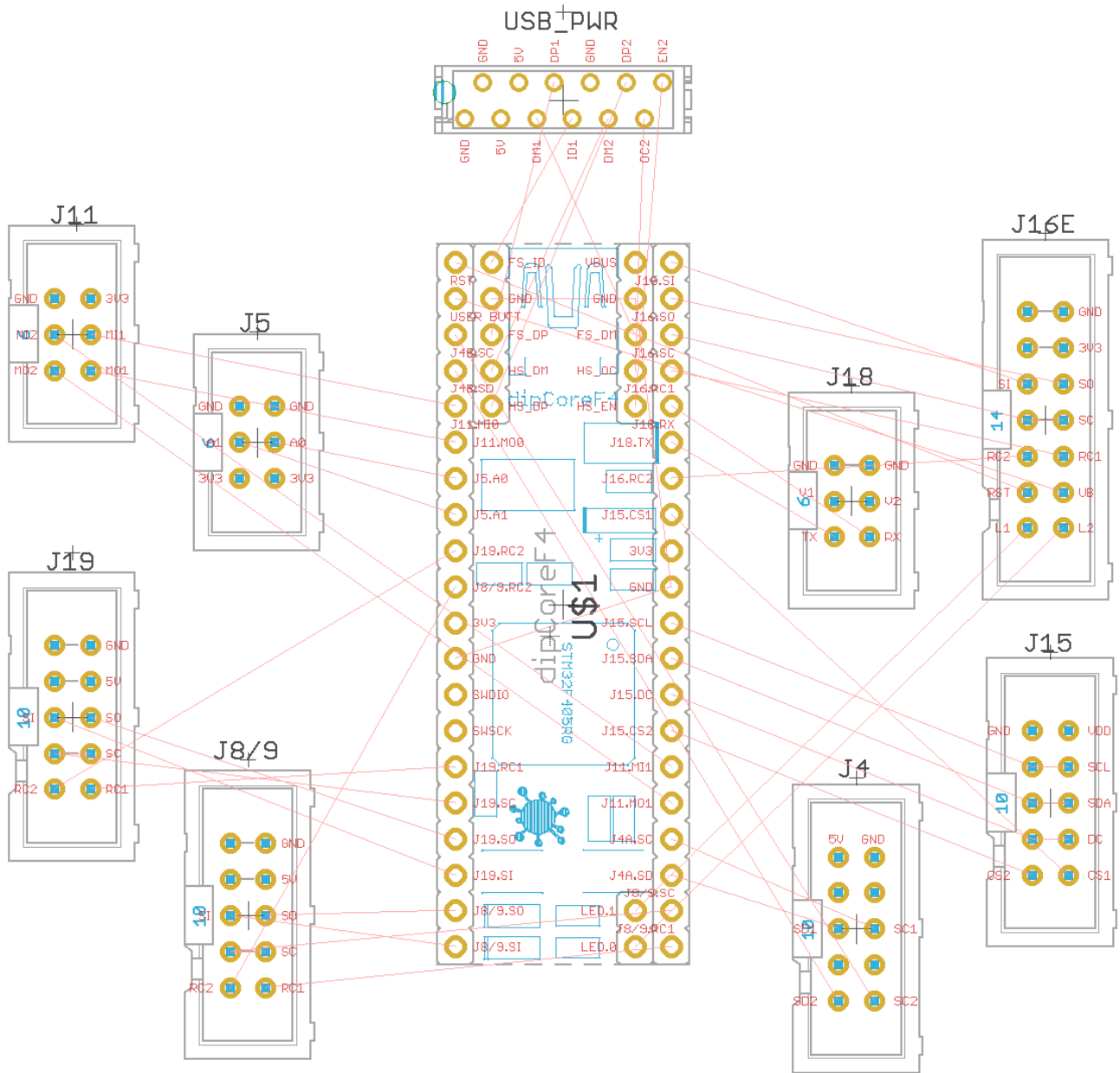

chart: ToDo



ToDo

STM32F407VG vs 405RG

Legacy STM32F407 and 405 share the same characteristics.

The 405RG is a TQFP64, a 10x10mm package and only 64 pins.

No Ethernet MAC and camera interface.

| Compare Attributes ✕ | | |
|---|--|--|
| <input checked="" type="checkbox"/> Show Differences | STM32F405RG ✕ | STM32F407VG ✕ |
| Description | High-performance foundation line, ARM Cortex-M4 core with DSP and FPU, 1 Mbyte Flash, 168 MHz CPU, ART Accelerator | High-performance foundation line, ARM Cortex-M4 core with DSP and FPU, 1 Mbyte Flash, 168 MHz CPU, ART Accelerator, Ethernet, FSMC |
| Package | LQFP 64 10x10x1.4 | LQFP 100 14x14x1.4 |
| Core | Arm Cortex-M4 | Arm Cortex-M4 |
| Operating Frequency (MHz) (Processor speed) | 168 | 168 |
| Co-Processor type | - | - |
| Co-Processor frequency (MHz) (max) | - | - |
| FLASH Size (kB) (Prog) | 1024 | 1024 |
| Data EEPROM (B) (nom) | - | - |
| RAM Size (kB) | 192 | 192 |
| Timers (typ) (16 bit) | 12 | 12 |
| Timers (typ) (32 bit) | 2 | 2 |
| Other timer functions | 2 x WDG, 24-bit down counter, RTC | 2 x WDG, 24-bit down counter, RTC |
| A/D Converters (12-bit channels) | 16 | 16 |
| A/D Converters (16-bit channels) | - | - |
| D/A Converters (typ) (12 bit) | 2 | 2 |
| Comparator | - | - |
| I/Os (High Current) | 51 | 82 |
| Display controller | - | - |
| CAN (typ) | 2 | 2 |
| CAN FD (typ) | - | - |
| I2C (typ) | 3 | 3 |
| SPI (typ) | 3 | 3 |
| I2S (typ) | 2 | 2 |
| USB Type | USB OTG FS + USB OTG FS/HS | USB OTG FS + USB OTG FS/HS |
| USART (typ) | 4 | 4 |
| UART (typ) | 2 | 2 |
| Connectivity supported | - | - |
| Integrated op-amps | - | - |
| Additional Serial Interfaces | - | Ethernet |
| Parallel Interfaces | FSMC, SD/MMC | FSMC, SD/MMC |
| Crypto-HASH | - | - |
| TRNG (typ) | true | true |
| SMPs | - | - |
| Supply Voltage (V) (min) | 1.8 | 1.8 |
| Supply Voltage (V) (max) | 3.6 | 3.6 |
| Supply Current (µA) (typ) (Lowest power mode) | 1.7 | 1.7 |
| Supply Current (µA) (typ) (Run mode (per Mhz)) | 215 | 215 |
| Operating Temperature (°C) (min) | -40 | -40 |
| Operating Temperature (°C) (max) | 105 | 105 |
| A/D Converters (typ) | - | - |
| Number of Channels (typ) | - | - |
| A/D Converters (typ) | - | - |
| Number of Channels (typ) | - | - |

ST STM32F4xx series

In MIOS32

We use the same peripheral drivers same family, some compilation defined conditions were added for the specific pinout and type, number of ports. `ToDo`

From:

<https://midibox.org/dokuwiki/> - **MIDIbox**

Permanent link:

<https://midibox.org/dokuwiki/doku.php?id=dipcore32&rev=1535626512>

Last update: **2018/08/30 10:55**

