

dipCore32

A reduced Core for your MIDIbox App, an STM32F405RG on a DIP40 board size.



Features

- MIOS32 uses same processor family and drivers(no deep change).
- Same internal hardware as Disco or wCore (speed, memory, peripherals, etc...) .
- Board pinout and package compatible with a MIOS8 PIC 😎
- USB connector onboard.
- 5V power input and led.
- 3.3V regulator and led on board.
- 74HCT541 on board for the 5V output ports.
- User and Reset buttons.
- 2 user leds.
- 8 extra pins for USB, buttons and leds.
- Your favorite Core is now a current component easy to integrate.

All commons MIOS32 ports are available except:

- General purpose J10x ports were removed.
- LCD port was reduced to a serial one, no more pins J15.D0-D7
- 2 UART only(2 MIDI In/2Out).
- 2 AIN channels only(e.g. pedal inputs)

Check the [dipBoard](#) for more details



PCB

4 layers PCB design.
Fits 4 layer mostly common design rules.

- min. drill 10mil
- min. width 6mil

ToDo

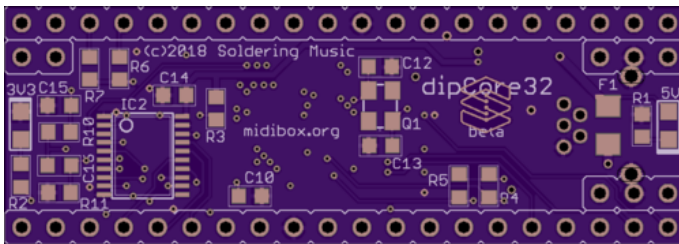
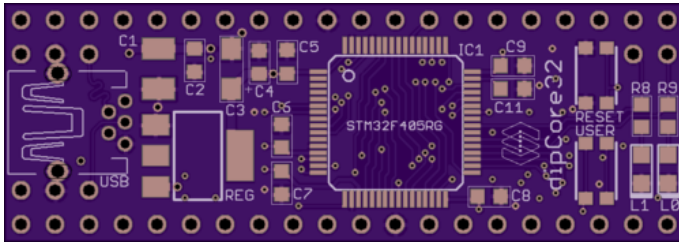

Top copper

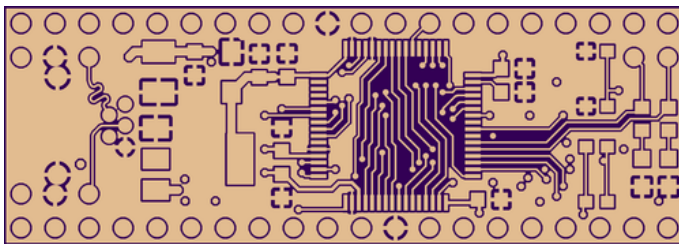

Internal 1



Internal 2

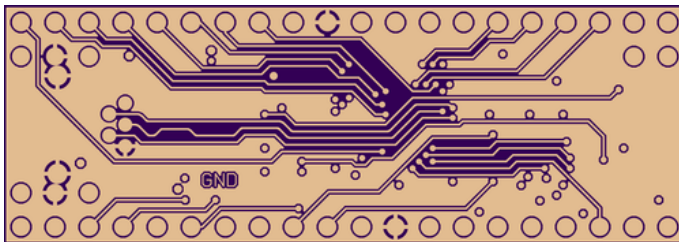

Bottom

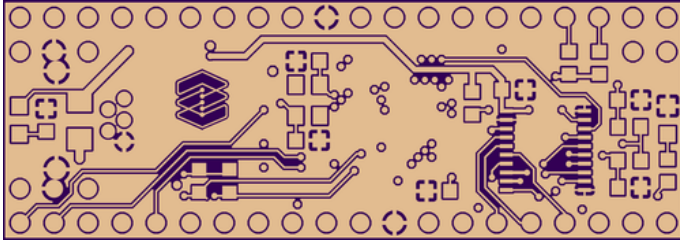

Pinout

PIC / MIO8		STM32F4 / MIO32								
DIP40	MIO8 Function	dipCoreF4			DISCO / wCore			Pin name		
		DIP40	LQFP64	STM32 F415RG	MIO32 Function	LQFP100	STM32F 407VG		Discovery F4 Pin	
2	J5 RA0	2	14	GPIO	USER BUTT	23	USER BUTT	P1.12	PA0(s)-WKUP(s)	
3	J5 RA1	3	58	I2C1_SCL	J4B.SC	92	I2C1_SCL	P2.23	PB6	
4	J5 RA2	4	59	I2C1_SDA	J4B.SD	93	USART1_RX	P2.24	PB7	
5	J5 RA3	5	17	USART2_RX	J11.MI1	26	USART2_RX	P1.13	PA3(s)	
6	J5 RA4	6	16	USART2_TX	J11.MD1	25	USART2_TX	P1.14	PA2(s)	
7	J5 RA5	7	15	ADC123_IN1	J5.A0	24	ADC123_IN1	P1.11	PA1(s)	
8	J5 RE0	8	25	ADC12_IN15	J5.A1	34	ADC12_IN15	P1.19	PC5(s)	
9	J5 RE1	9	40	SP3_RC2(GPIO)	J19.RC2	66	LCD:SER/E2	P2.46	PC9	
10	J5 RE2	10	26	SPI2_RC2(GPIO)	J8/9.RC2	35	ADC12_IN8	P1.22	PB0(s)	
13	OSC1	13	46	JTMS-SWDIO		72	JTMS-SWDIO	P2.42	PA13	
14	OSC2	14	49	JTCK-SWCLK		76	JTCK-SWCLK	P2.39	PA14	
15	J6/7_RC	15	50	SPI3_RC1(NSS)	J19.RC1	77	SPI3_NSS:RC1	P2.40	PA15	
16	J6/7_SC	16	55	SPI3_SCK	J19.SC	89	SPI3_SCK	P2.28	PB3	
17	J6/7_SO	17	57	SPI3_MOSI	J19.SO	91	SPI3_MOSI	P2.26	PB5	
18	J6/7_SI	18	56	SPI3_MISO	J19.SI	90	SPI3_MISO	P2.25	PB4	
19	J8/9 S0	19	11	SPI2_MOSI	J8/9.SO	18	N.U.	P1.9	PC3(s)	
20	J8/9 SI	20	10	SPI2_MISO	J8/9.SI	17	ADC123_IN12	P1.10	PC2(s)	
21	J8/9 RC	21	27	SPI2_RC1(GPIO)	J8/9.RC1	36	ADC12_IN9	P1.21	PB1(s)	
22	J8/9 SC	J10 SC	22	34	SPI2_SCK	J8/9.SC	52	SPI2_SCK	P1.37	PB13
23	J10 RC	23	30	I2C2_SDA	J4A.SC	48	I2C2_SDA	P1.35	PB11	
24	J10 SO	24	29	I2C2_SCL	J4A.SD	47	I2C2_SCL	P1.34	PB10	
25	J11 TX	25	51	UART4_TX	J11.MD2	78	DAC_CK(discovery)	P2.37	PC10	
26	J11 RX	26	52	UART4_RX	J11.MI2	79	LCD:SER/R/W	P2.38	PC11	
27	J14	27	8	GPIO	J15.CS2	15	OTG_FS_EN	P1.8	PC0(s)	
28	J15 RS	J10 MD	28	54	GPIO	J15.DC	83	UART5_RX	P2.34	PD2
29	J15 RW	J10 MD	29	53	GPIO	J15.SDA	80	UART5_TX	P2.35	PC12
30	J15 E	30	9	GPIO	J15.SCL	16	ADC123_IN11	P1.7	PC1(s)	
33	J15 D0	33	33	GPIO	J15.CS1	51	SPI2_NSS:RC1	P1.36	PB12	
34	J15 D1	34	24	SPI1_RC2(GPIO)	J16.RC2	33	ADC12_IN14	P1.20	PC4(s)	
35	J15 D2	35	62	CAN1_TX	J18.TX	96	I2C1_SDA	P2.20	PB9	
36	J15 D3	36	61	CAN1_RX	J18.RX	95	SP3_RC2	P2.19	PB8	
37	J15 D4	37	20	SPI1_RC1(NSS)	J16.RC1	29	ADC12_IN4	P1.16	PA4(s)	
38	J15 D5	38	21	SPI1_SCK	J16.SC	30	SPI1_SCK	P1.15	PA5(s)	
39	J15 D6	39	22	SPI1_MISO	J16.SI	32	SPI1_MOSI	P1.17	PA7(s)	
40	J15 D7	40	23	SPI1_MOSI	J16.SO	31	SPI1_MISO	P1.18	PA6(s)	
		41	43	OTG_FS_ID	J1.D1	69	OTG_FS_ID	P2.41	PA10	
		43	45	OTG_FS_DP	J1.DP1	71	OTG_FS_DP	CN5(USB)	PA12	
		44	35	OTG_HS_DM	J1.DM2	53	SPI2_MISO	P1.38	PB14	
		45	36	OTG_HS_DP	J1.DP2	54	SPI2_MOSI	P1.39	PB15	
		46	42	OTG_FS_VBUS	J1.VBUS	68	OTG_FS_VBUS	P2.44	PA9	
		48	44	OTG_FS_DM	J1.DM1	70	OTG_FS_DM	CN5(USB)	PA11	
		49	3	OTG_HS_OC	J1.OC2	8	J10/D9	P2.9	PC14(s)-OSC32_IN(s)	
		50	4	OTG_HS_EN	J1.EN2	9	J10/D10	P2.10	PC15(s)-OSC32_OUT(s)	
		51	38	LED BLUE	LED.2	64	DAC_MCK(discovery)	P2.48	PC7	
		52	37	LED RED	LED.1	63	USART6_TX	P2.47	PC6	
		2		N.U.		7	J10/D8	P2.12	PC13(s)	
		5		OSC_IN		12	N.U.	P2.7	PH0(s)-OSC_IN	
		6		OSC_OUT		13	N.U.	P2.8	PH1(s)-OSC_OUT	
		28		N.U.		37	SPI1_RC1	P1.24	PB2	
		39		N.U.		65	LCD:SER/E1	P2.45	PC8	
		41		N.U.		67	LCD:RS	P2.43	PA8	

full

The 405RG is a TQFP64, a 10x10mm package and only 64 pins.

No Ethernet MAC and camera interface.

Compare Attributes ✕		
<input checked="" type="checkbox"/> Show Differences	STM32F405RG ✕	STM32F407VG ✕
Description	High-performance foundation line, ARM Cortex-M4 core with DSP and FPU, 1 Mbyte Flash, 168 MHz CPU, ART Accelerator	High-performance foundation line, ARM Cortex-M4 core with DSP and FPU, 1 Mbyte Flash, 168 MHz CPU, ART Accelerator, Ethernet, FSMC
Package	LQFP 64 10x10x1.4	LQFP 100 14x14x1.4
Core	Arm Cortex-M4	Arm Cortex-M4
Operating Frequency (MHz) (Processor speed)	168	168
Co-Processor type	-	-
Co-Processor frequency (MHz) (max)	-	-
FLASH Size (kB) (Prog)	1024	1024
Data EEPROM (B) (nom)	-	-
RAM Size (kB)	192	192
Timers (typ) (16 bit)	12	12
Timers (typ) (32 bit)	2	2
Other timer functions	2 x WDG, 24-bit down counter, RTC	2 x WDG, 24-bit down counter, RTC
A/D Converters (12-bit channels)	16	16
A/D Converters (16-bit channels)	-	-
D/A Converters (typ) (12 bit)	2	2
Comparator	-	-
I/Os (High Current)	51	82
Display controller	-	-
CAN (typ)	2	2
CAN FD (typ)	-	-
I2C (typ)	3	3
SPI (typ)	3	3
I2S (typ)	2	2
USB Type	USB OTG FS + USB OTG FS/HS	USB OTG FS + USB OTG FS/HS
USART (typ)	4	4
UART (typ)	2	2
Connectivity supported	-	-
Integrated op-amps	-	-
Additional Serial Interfaces	-	Ethernet
Parallel Interfaces	FSMC, SD/MMC	FSMC, SD/MMC
Crypto-HASH	-	-
TRNG (typ)	true	true
SMPs	-	-
Supply Voltage (V) (min)	1.8	1.8
Supply Voltage (V) (max)	3.6	3.6
Supply Current (µA) (typ) (Lowest power mode)	1.7	1.7
Supply Current (µA) (typ) (Run mode (per Mhz))	215	215
Operating Temperature (°C) (min)	-40	-40
Operating Temperature (°C) (max)	105	105
A/D Converters (typ)	-	-
Number of Channels (typ)	-	-
A/D Converters (typ)	-	-
Number of Channels (typ)	-	-

ST STM32F4xx series

In MIOS32

We use the same peripheral drivers same family, some compilation defined conditions were added for the specific pinout and type, number of ports. `toDo`

From:

<https://midibox.org/dokuwiki/> - **MIDIbox**

Permanent link:

<https://midibox.org/dokuwiki/doku.php?id=dipcore32&rev=1535631703>

Last update: **2018/08/30 12:21**

