

MB-LRE8x2CS rev 4.6

16 LEDrings / 16 Encoders Control Surface PCB

Welcome to the wiki page of the control surface board featuring:

- DINx4 module,
- Improved DOUTx4 module,
- 16 LEDrings of (15+1) LEDs each,
- 16 encoders (with or without switch).

The last revision of the PCB is rev 4.6.

It is a very practical and cheap way to make a midi controller with adding only a core or make a more important controller without having to wire LEDrings.

PCB

The PCB have components soldered on the two sides.

Top side: Encoders and LEDs.

Back side: All others components (see [BOM below](#)).

The board is 3,335 x 13,452 inch (341,7 x 85,1 mm): slightly less than 2U standard.

The previous revision (2.5) was 3,368 x 13,472 inch (342,2 x 85,5 mm).

The (external) diameter of each LEDring is 34 mm with the use of 3mm LED.

To comply to the footprint of 2x5x7mm rectangular LEDs, the diameter (from the centers of the LEDs - except the lowest one) of the LEDring is now slightly less than 31mm instead of 30mm.

The pitch between each controller remains the same as in the previous version (1,684 inch).

Pictures

Mix of the Rev2.5 and protoboard pictures (Note this is not the last versions but they have practically the same dimensions and LEDs/Encoders positioning):



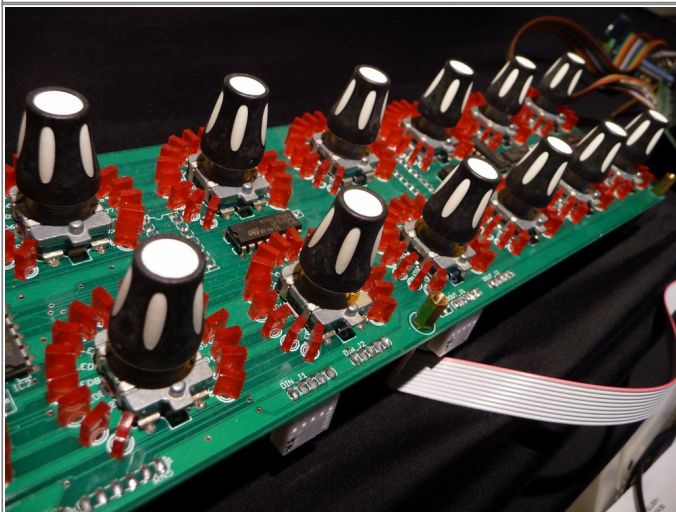
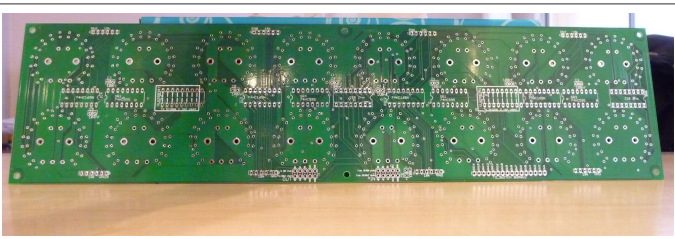
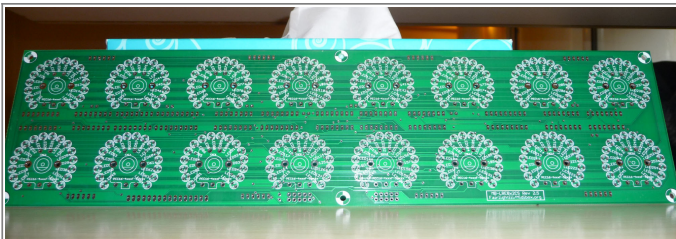

Protoboard in action:

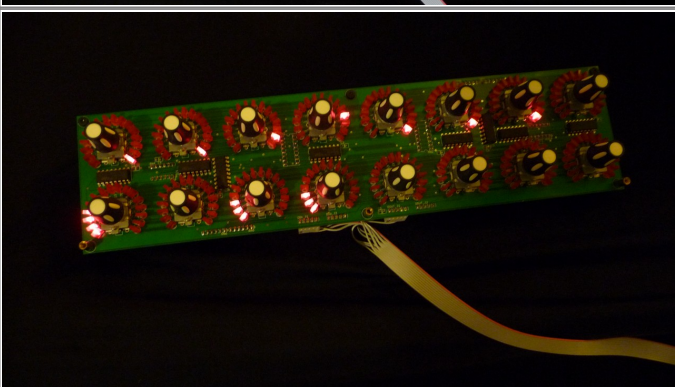
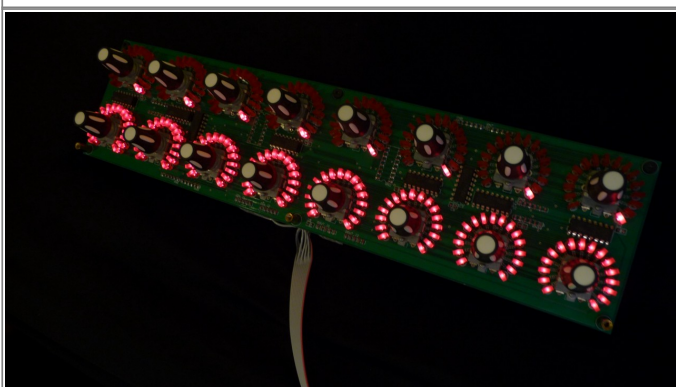
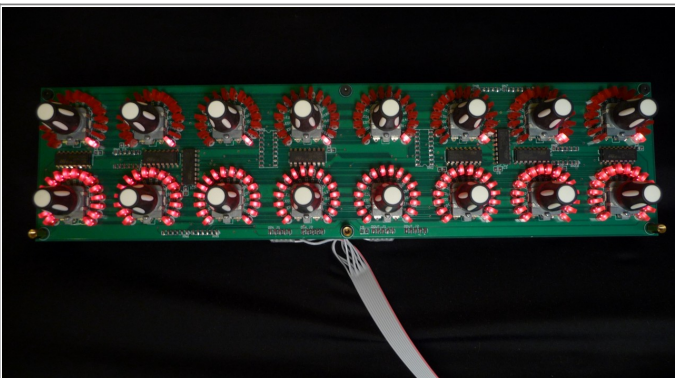
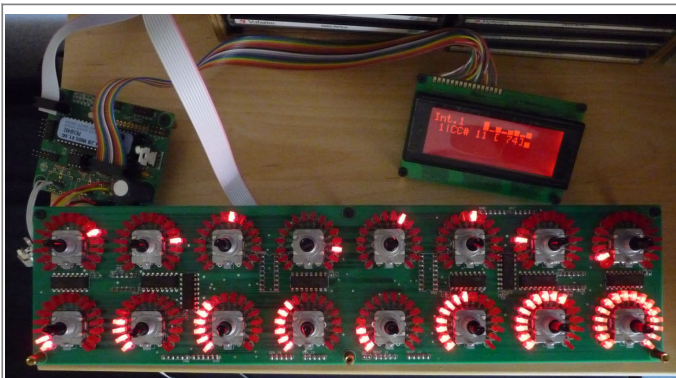

You can see the LEDring animation in this [poorly quality video](#).

Dimensions

All measurements are given in mils unless otherwise indicated.

1 mil = 0,001 inch = 0,0254 mm. You can use this [converter utility](#).



Layout



You can download a better definition version (without ground surfaces for better visibility) [here](#).

Silkscreen

[Top silkscreen.](#)

[\(mirrored\) Bottom silkscreen.](#)

Schematic

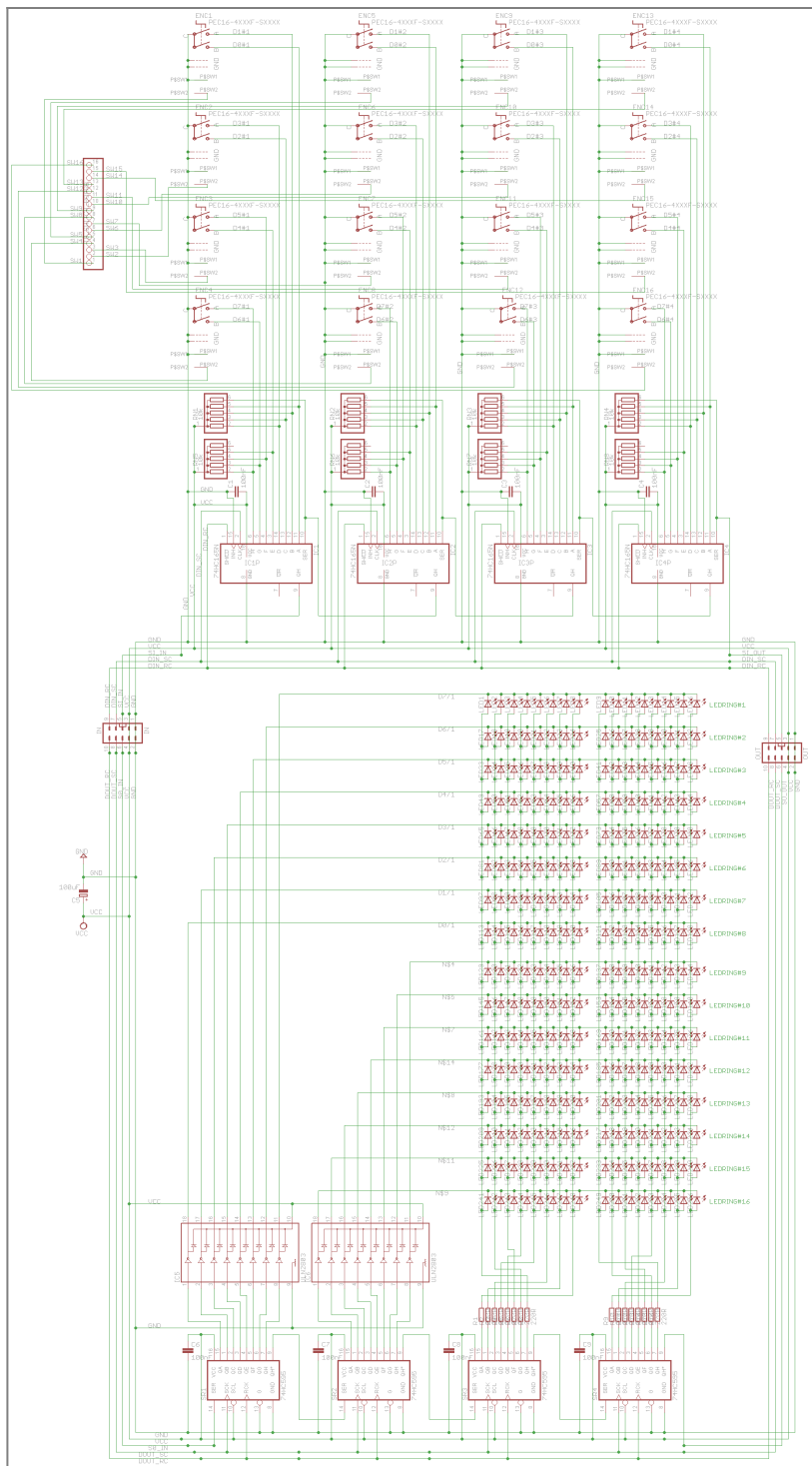

You can download a better definition version [here](#).

Coordinates

The origin (0;0) is the bottom left corner of the board.

Note: Be very careful if you use vectorial software (to draw your front panel e.g.) because usually it takes as origin of each part the left corner of the part and not the center of the part !!!

Take a look at the *.SVG section below.

LEDs/Encoders

You will find the coordinates of LEDs/Encoders in this [files](#).

You will note that the encoders are upside-down because to win some space inside the LEDring. Because they are endless, the use of them is not impacted.

3mm board holes

Coordinates of the six holes (in inch):

X	Y
1,674	0,15
6,726	0,15
11,778	0,15
0,15	3,2
6,726	3,2
13,302	3,2

BOM

Qty	Device	Parts	REICHEL	MOUSER	Note
4	74HC165	IC1, IC2, IC3, IC4	74HC165	511-M74HC165	
2	ULN2803 Transistors Darlington arrays	IC5, IC6	ULN2803A	595-ULN2803AN	
4	74HC595	SR1, SR2, SR3, SR4	74HC595	511-M74HC595	
8	Ceramic Cap 100nF=0,1uF "104"	C1→C4 & C6→C9	Z5U-2,5 100n	80-C412C104K5R	
1	Polarized Electrolytic Capacitor 100 uF	C5	rad 100/16	140-REA101M1CBK0611P	
8	10k 6 Pin SIL resistor network "103"	RN3→RN10	SIL 6-5 10K	264-10K-RC	
16	220 Ohm metal film resistor	R1→R16	METALL220	MF1/4DCT52R2200F	You won't be able to use resistor network this time because each resistor is 60° rotated
2	2×5 pins DIL Shrouded Header	"IN", "OUT"	WSL 10G	710-61201021621	Cheap model on Ebay
1	1×16 pins SIL Header	"TO_SWITCH_BOARD"	SL1X36G 2,54	649-68001-416HLF	Optional (switched encoders)
16	PEC16-4020F-N0024	ENC1→ENC16	-	652-PEC16-4020FN0024	Undetended - without build-in switch

Qty	Device	Parts	REICHELT	MOUSER	Note
	or PEC16-4020F-S0024		-	652-PEC16-4020FS0024	Undetended - with build-in switch
10	Socket 16 pins	-	GS 16	571-1-390261-4	Cheap model on Ebay
2	Socket 18 pins	-	GS 18	571-1-390261-5	Cheap model on Ebay
256	LED 3mm or rectangular (2x5x7mm)	LED1→LED256	LED 3MMRT	-	Reichelt model recommended

LED black list

Since Tk discovered a [brightness problem](#) with some rectangular 5x2x7mm LEDs, we found useful to create a list of LEDs wich are successfully or unsuccessfully tested. Members are welcome to edit this page to add their LED feedback.

Model	Type	Mcd	Link	Good	Not good	With ULNs	Author
Kingbright WP103HD	2x5x7mm rectangular	2	Mouser		X	?	Tk
LED 3MM RT	3mm round	1.3>5	Reichelt	X		?	Tk
“10001”	2x5x7mm rectangular	?	auspiciousmall.com	X	X	No(prototype)	Fairlightiii
Kingbright L-934ID	3mm round	25	Segor Electronics	X		?	rvlt
Kingbright WP132XID	3mm round	10>25	Mouser	X		No	grizz
Kingbright WP132XID	3mm round	10>25	Mouser		X	Yes	MaG2k
Kingbright WP113SRDT	2x5x7mm rectangular	36>60	Mouser		X	Yes	MaG2k
smashTV is selling	3mm round	?	smashTV		X	Yes	MaG2k
Tayda Electronics	3mm round	4k>6k	Tayda Electronics	X		Yes	MaG2k

Note: Regarding condition of each test (ambient luminosity, etc...) and sensibility of each person, this results should be taken with reserve.

Components

LEDs & LEDring

Each LEDring is composed of 16 LEDs: 15 on the LEDring itself and one on the lowest part of the LEDring. Thorsten advised me about this type of implementation (odd number of LEDs) because it is an [industry standard](#) and to have better feedback for some controls (PANoramic e.g.).

You can use 3mm LEDs or 2x5x7mm rectangular LEDs (because the different angles of the LEDs in the LEDring) or all other LED with 0.1 inch (2,54 mm) leads spacing.

There's not enough space for 5mm LEDs.



The LED polarity: the cathode (short leg) has to show to the center of the LED ring:



In this revision (4.6) the silkscreen of the LEDring#1 indicate the "+" (anode) and the "-" (cathode).

Encoder

You can use 16mm "standard" encoders (ALPS STEC16, Bourns PEC16-4xxxF-Nxxxx series, encoders sell by [voti](#), ...).

You can use instead PEC16-4xxxF-Sxxxx series (with built-in switch). Probably others built-in switch encoders comply the PCB footprint but you have compare their [datasheets](#).

16 pins SIL header

If you use switched encoders, one of the two pins of the built-in switch is grounded while the other pin is connected to a pin of this SIL connector. The silkscreen include the name of each switch.

2x5 pins DIL headers

They are 1:1 with J8/J9 of Core8/Core32/LPC17 so you can use practical [IDC female Connector](#) or still more easier [pre-built 2x5 Pin IDC Ribbon Cable](#).

Be careful to the [connection to the MBHP_CORE_LPC17 module](#) because it could be confusing, since the SO pin of J8/9 has to be connected to the SI pin of the LRE2x8 board, and SI to the SO pin (for MBHP_DOUT/DIN we usually have the same names for these signals, this detail has been overlooked). *All should be OK in this revision.*

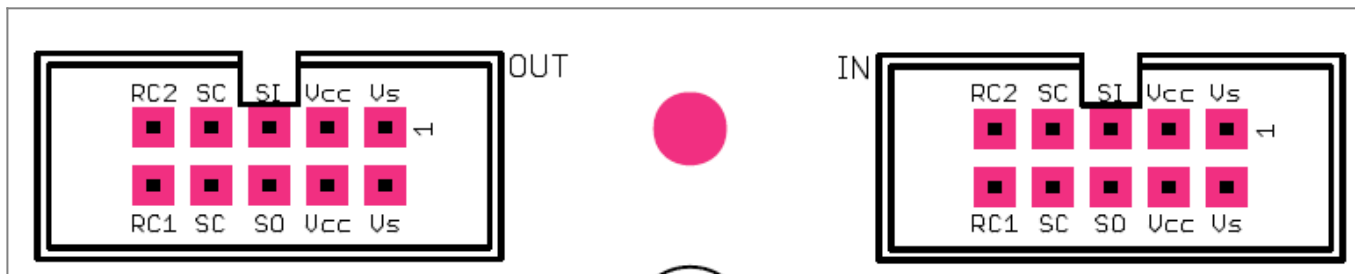

ULN2803

This component provide more current to the matrix LED than the 74HC595 shift registers can and improve the brightness of the LEDs.

Thorsten made deepest tests on this component and he concluded that it improves greatly the current toward the LEDs matrix so it is now highly recommended to use them.

10kOhm 6 Pin SIL resistor network

Be careful when sourcing SIL resistor networks because a 6 Pin SIL resistor network can be 5 commoned resistors (what you need here) or 3 independant resistors. A point on the silkscreen prevent to solder upside-down the resistor networks (a point is also indicated on the resistor network).

Polarized Electrolytic Capacitor 100 uF

It is the only polarized cap of the board. The silkscreen indicate the “+” and “-” signs on the board.

Diagram interconnection

One board connection

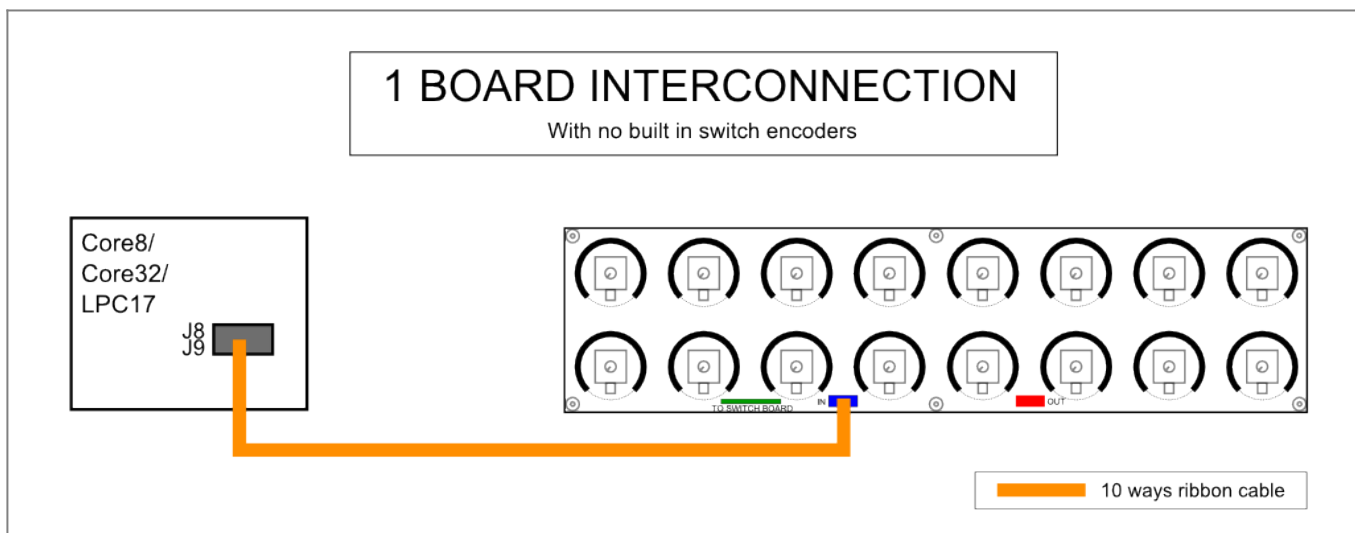

Only one 2x5 Pin IDC Ribbon Cable is necessary to connect the board.

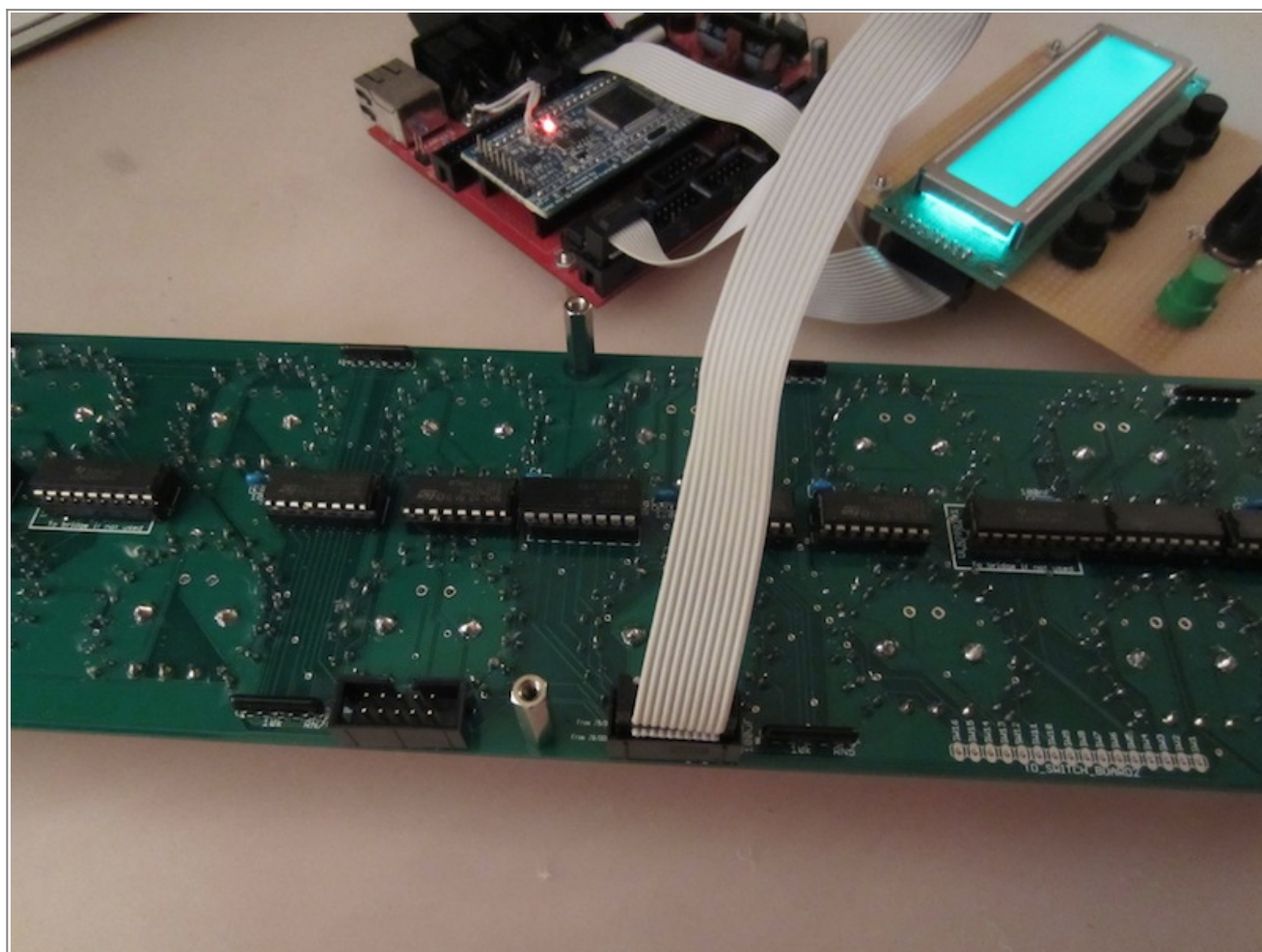

Global interconnection

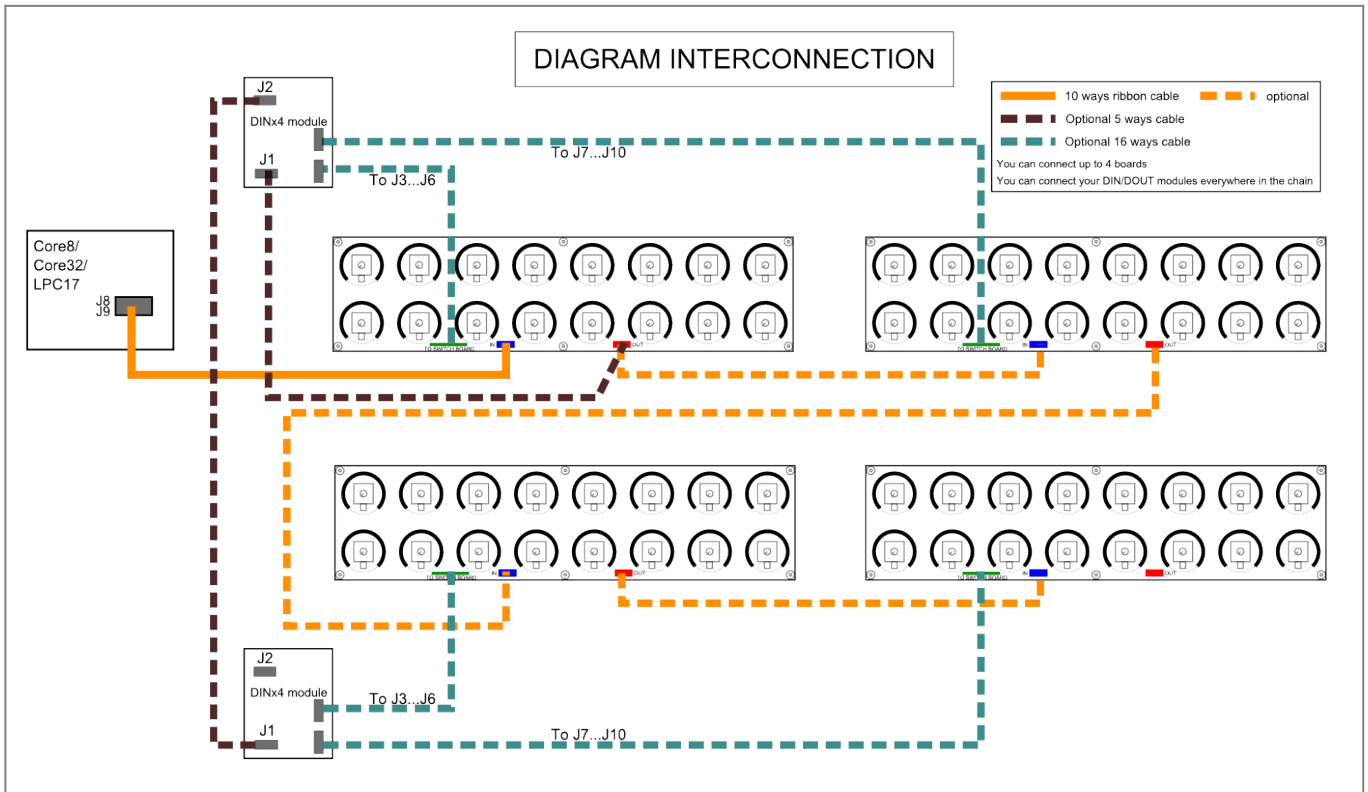

You can download a better definition version [here](#).

You can chain up to **8** (the drawing above indicates 4) of this board (MIDIbox NG). You only have to connect the “OUT” connector to the “IN” connector of the following board. You can connect yours extra DIN/DOUT modules before (“IN” connector) or after (“OUT” connector).

Software configuration

I refer you to the threads opened by Thorsten about the configuration of the MIOS in [single context](#) and [4 boards chained together](#).

Frontpanel *.SVG files

This is 2 useful files if you want making a frontpanel:

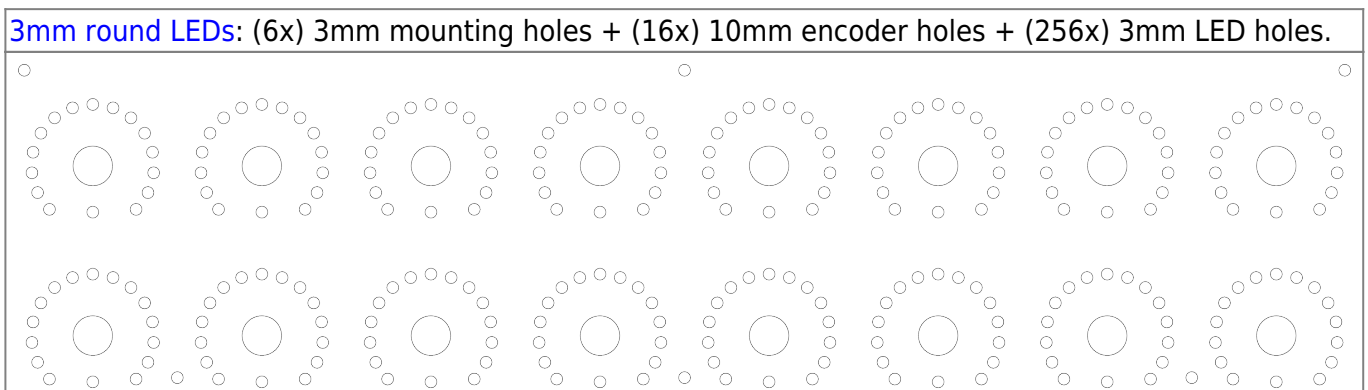

2x5x7 rectangular LEDs: (6x) 3mm mounting holes + (16x) 10mm encoder holes + (256x) 2x5mm LED holes.

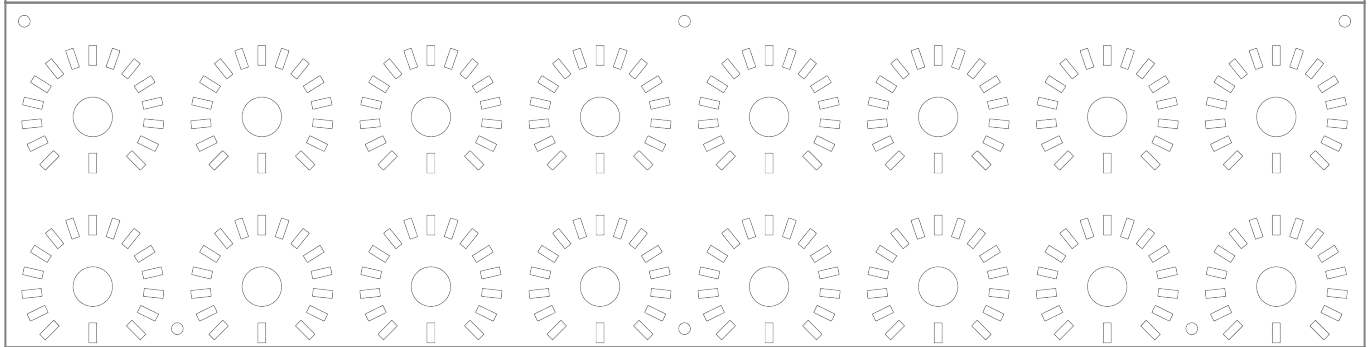

Consult your datasheet to check if the opening dimension fit your LED.

I provide all this information without warranty.

Feel free to contact me to make corrections.

Jerome aka Fairlightiii.

From:

<https://midibox.org/dokuwiki/> - **MIDIbox**

Permanent link:

https://midibox.org/dokuwiki/doku.php?id=mb-lre8x2cs_rev4.6&rev=1393257900

Last update: **2014/02/24 16:05**

