

# MB-ModulBox NG

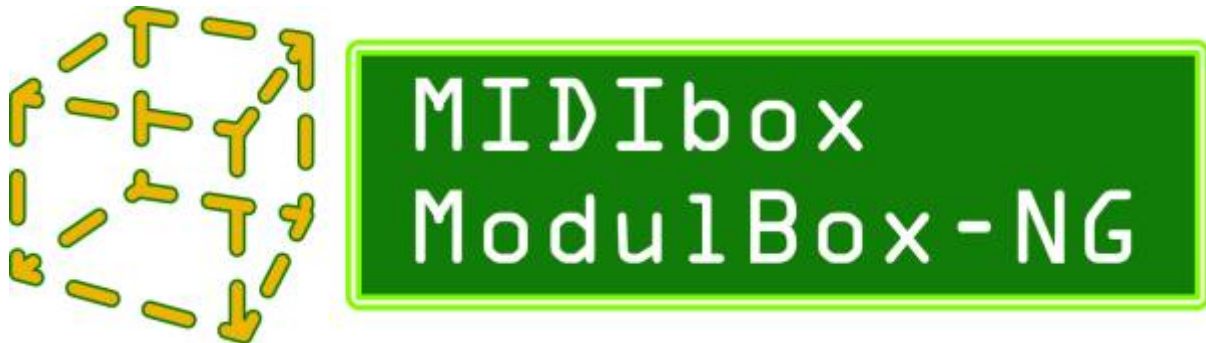

*Under Heavy Development @ 9/8/2016*

## Introduction

The MB-Modulbox-NG Project is a modern version of the **Modulbox** project .  
In short words, it's a **Eurorack-size compliant Modular MIDIbox Control Surface** based upon MB-NG.

From a **Main Part**, **small modules would be chained to Build the custom-sized control surface of your dreams by choosing the MIDI controls you want.**

Main part would also allow **Access to Menus for configuring and saving things on SD Card** , and optionnal **External Analog Inputs/Outputs** to trigger from external sensors and/or drive your analog synth.

**Each Small Module will have a Different type of Interaction** and will include Digital Shift Registers and/or Multiplexers For Analog lines . Then modules would be chained one to another up to main part.

Modules **Chain Connectors will be 2.54mm dual row pinheader** (Molex?) and will carry Digital/Analog bus lines and Current supply. PSU Main input will be on main part PCB.

## Main Part Features

1. Core32 Board
2. **Standard Control Surface** with 6 Tactile switches, Push - Encoder , **OLED** Graphical screen
3. **SD Card Slot** (+USB in?)
4. **2xMIDI IN + 2xMIDI OUT 2.5mm jack Plugs**
5. **Optionnal 16x3.5mm jacks** for external **Analog Ins/Analog Outs** with External interfaces for expanding.

# Community users working on it

- **Ksir** - Modulbox Original Designer - PCB Design - Programming
- **Psykhaze** - Documentation - Frontpanel design - PCB Design - Programming

## Getting Involved ?

Just let a Private message on the forum to users already involved

## Software Tools used

- **Inkscape Vector Drawing Software** - Front panel Concept Drawing
- **KiCAD PCB** - PCB Design | **KiCAD Libraries**
- **FreeCAD 3D Technical Drawing** - Case Design
- **Code::Blocks Integrated Development environment** - GUI Software - MIOS programming
- **JUCE** - Cross-Platform Audio/MIDI/GUI Library

## Architecture

### Modulbox-NG

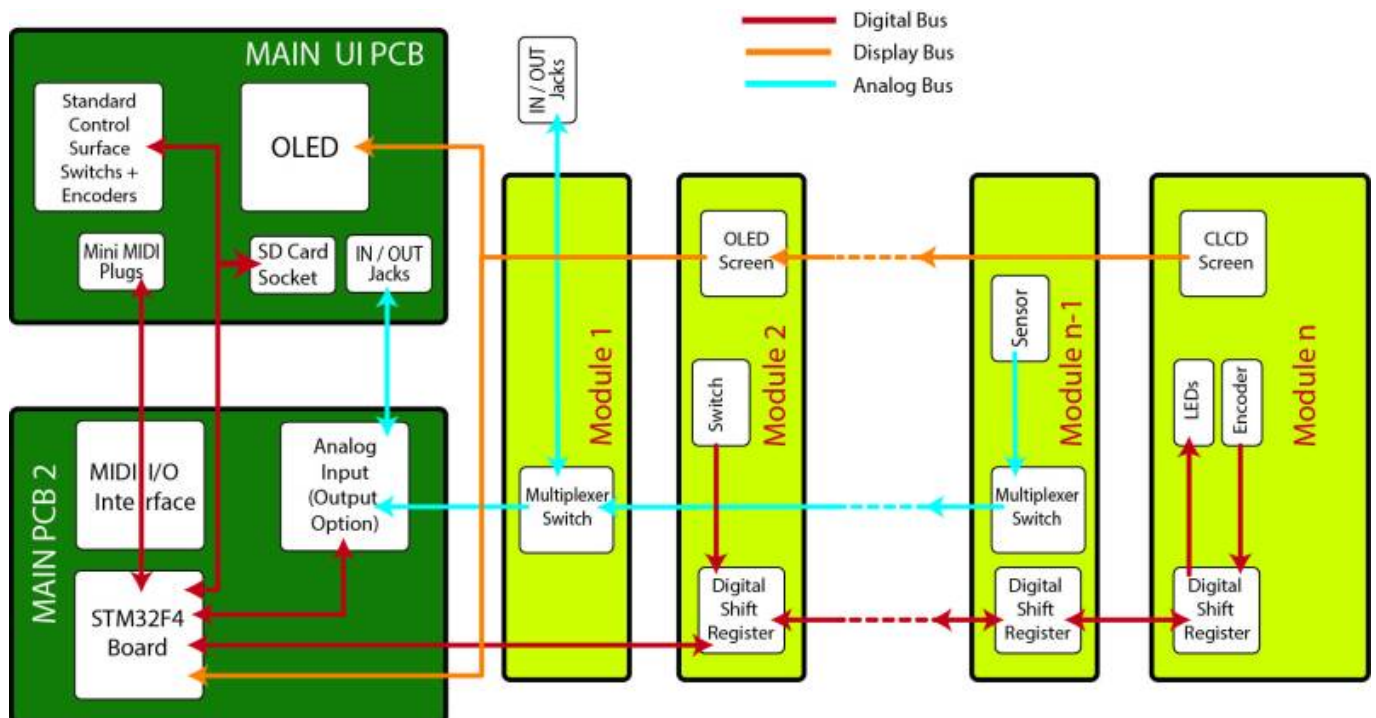

### Eurorack design

- **Eurorack Design is 3U Height** So frontpanel = 5,25" = 133mm-rails = **128,5mm** Height .

Sandwich Design is ok here due to non heating components and allow to spare space.

- **Modules Frontpanels are 8HP-multiple wide (8HP=40,3mm)** see [Eurorack Specification](#).

Frontpanel back spacers glued with JB-weld to avoid front screwing. [Eurorack Templates PDF](#)

- **PCB Size is 100mm height** To stay compliant to [Eurocard Specification](#)

### Splitted View

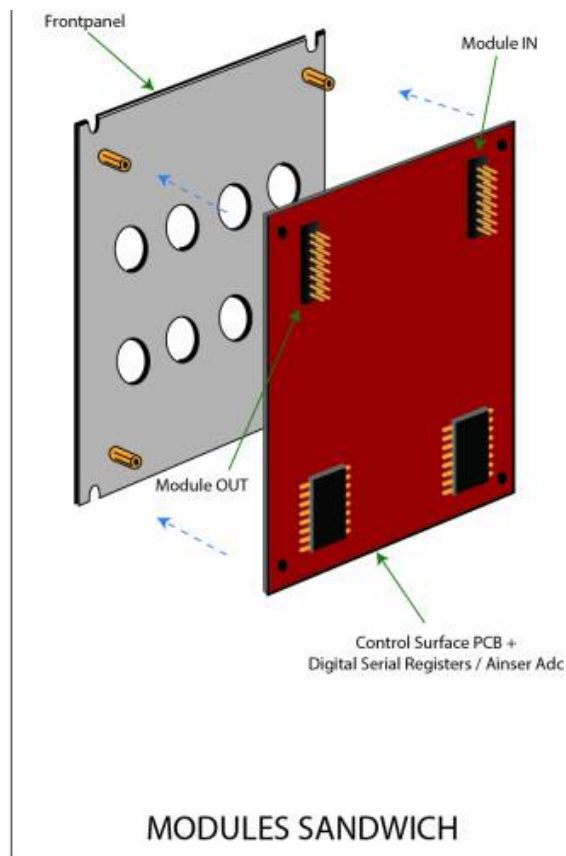
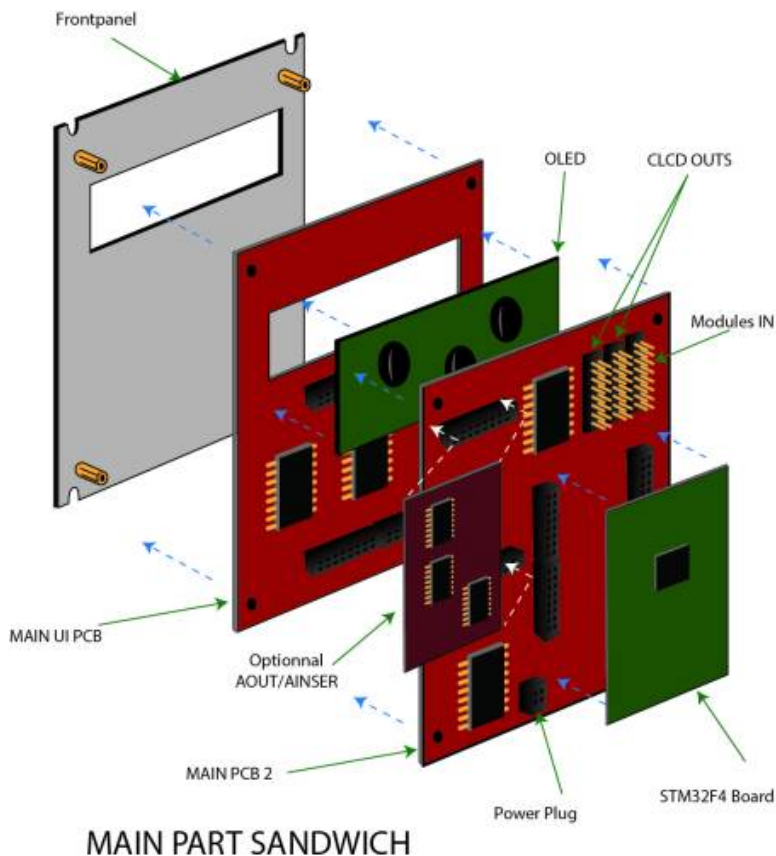

### Tech Demos Videos





**Video**



**Video**



**Video**



**Video**



**Video**



**Video**

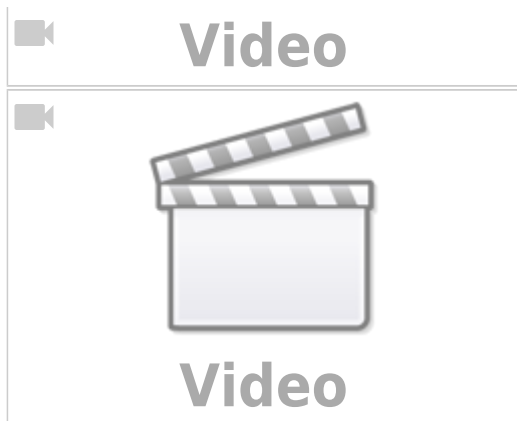

## Modules List + UI Parts

Module	N°	Analog	LED	Encoders	Switches	HP	User	Display
Main UI+Main PCB	1	Jacksx16		x1 PushRotary	Tactilex6	24	Psykhaze	Graphic-OLEDx1
Horizontal 4xOLEDS SCSE	2			x1 PushRotary	Tactilex7	24		Small-OLEDx4
Vertical 4xOLEDS	3					16		Small-OLEDx4
LCD Vertical SCS	4			x1 PushRotary	Tactilex(4+4+2)	16		CLCD 20x4
LCD Horizontal SCSE	5			x2 PushRotary	Tactilex22	32	Psykhaze	2xCLCD 40x4
Encoders x8	6			x8 PushRotary		8	Ksir	
Pots x8	7	Pots x8				8	Ksir	
LED Ring Encoders x4	8		16x4 3mm	x4 PushRotary		8		
Faders 2x2	9	Fadersx4				8		
Light-Fader 2x2	10	Light-Fadersx4				8		
Long Faders x2	11	Long Fadersx2				8	Psykhaze	
Motor Fader x1	12	Motor Fader	16x3mm			8	Psykhaze	
Switches x8 A	13				Tactilex8	8	Ksir	
Switches x8 B	14		8xBicolor		Toggle 3 polesx8	8	Ksir	
Light-Switches x8 A	15		Bicolor Opt		Light Tactilex8	8	Ksir	
Light-Switches x8 B	16				Light Togglex8	8	Ksir	
Numeric Displayx2	17			x2 PushRotary		8		2x Numeric
Numeric Displayx4	18			x4 PushRotary		16		4x Numeric

Module	N°	Analog	LED	Encoders	Switches	HP	User	Display
8x8 LED Modulation Matrix	19		x(8x8)3mm		Tactilex(8+8)	16		
16x16 LED DotMatrix	20					16	Psykhaze	4xDotMatrix
8x16 RGB DotMatrix	21					16	Psykhaze	2xDotMatrix
Additional Analog In or Out Interface	22	Jacksx8		x8 PushRotary	Toggle 4 polesx2	16	Psykhaze	Small-OLEDx2
Crosspoint Matrix 8x4(x4)	23	Jacksx(8+4)	x(8x4) 3mm		Toggle 4poles, Tactilex(8+4)	16	Psykhaze	
Adafruit Silicon 3mm 8x8 Matrix	24		x(8x8)3mm		Adafruit Silicon (4x4)x4	24	Psykhaze	
Joystick	25	2xJoystick	2xRGB			8		
Linear Touch	26	1x(Force)Linear Sensor	8xWS2812			8	Psykhaze	
Circular touch	27	1x(2x)Circular Sensor	16(x2)xWS2812			16	Psykhaze	
Force touch	28	4xForce touch	4xRGB			8		
MiniDeck DJ Control	29	1xScratchFader+1xVertical Fader	x8 3mm	x1 Code Wheel +x3 PushRotary		32		

## Frontpanels Layouts

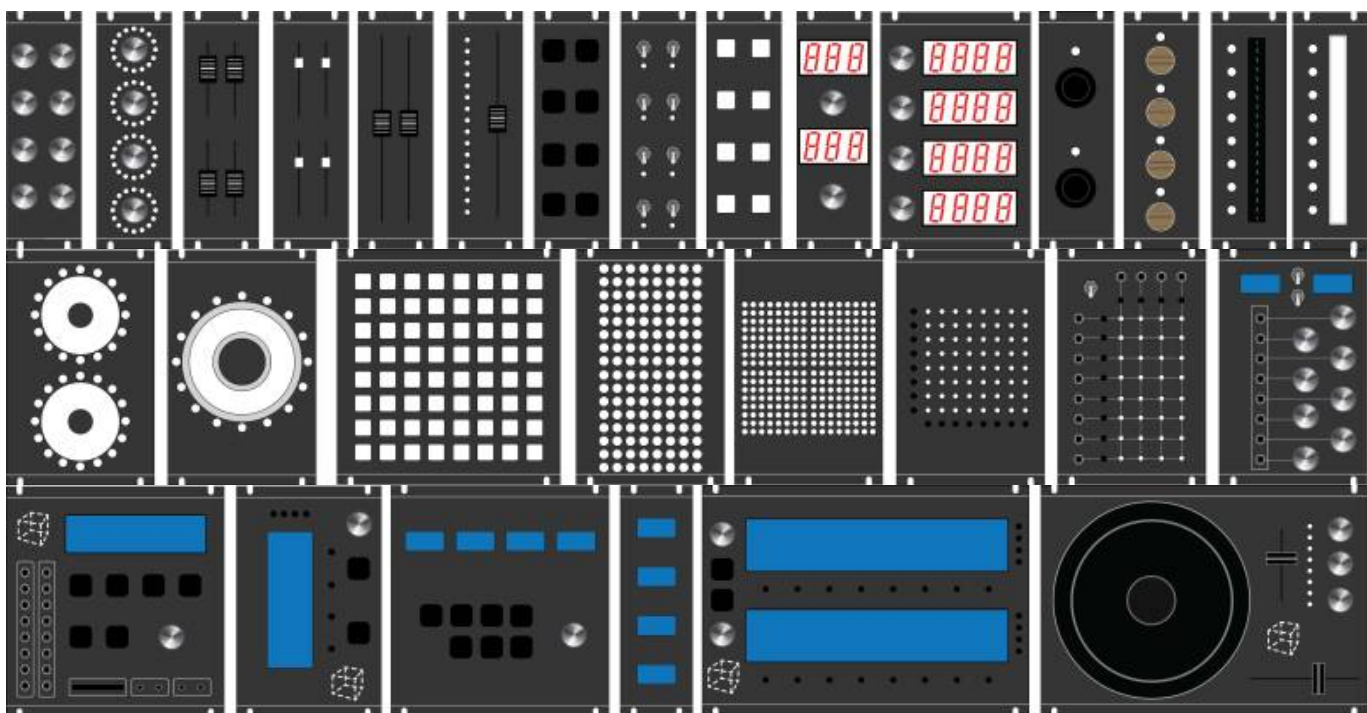

## Modules Ins/Outs + Related Parts

.	1	2	3	4	5	6	7	8	9	10	11	12	13	14	15
Digital Ins	8	0>16	/	12	30	16	/	8	/	/	/	?	8	24	8
Digital Outs	/	/	/	/	/	/	/	16	/	/	/	16+?	/	16	8>16
Analog Ins	/	/	/	/	/	/	16	/	8	8	4	?	/	/	/
CLCD #	/	/	/	1	2	/	/	/	/	/	/	/	/	/	/
OLED #	1	1>8	4	/	/	/	/	/	/	/	/	/	/	/	/
.	16	17	18	19	20	21	22	23	24	25	26	27	28	29	
Digital Ins	16	4	8	16	/	/	24	15	32	/	3	/	/	12	
Digital Outs	8	16	32?	16	16	32	/	16	/	6	/	/	12	8	
Analog Ins	/	/	/	/	/	/	0>8	/	/	8	/	3>6	8	8	
CLCD #	/	/	/	/	/	/	/	/	/	/	/	/	/	/	
OLED #	/	/	/	/	/	/	1	/	/	/	/	/	/	/	

## Parts References

### Parts Datasheets

Designation	Datasheet Link	Reference
Switch Rotary Encoder	<a href="#">Alps EC11E</a>	EC11E15244B2
5mm RGB LED	<a href="#">RGB LED</a>	SL-R596CR4G3B5W-F12
Tactile Switch	<a href="#">Small Round Tactile Switch</a>	SKHHDTA010
Tactile Switch 2	<a href="#">Square Tactile Switch</a>	03.0752
Light-Tactile Switch	<a href="#">Square Light Tactile switch</a>	B3W-9000-G1N, B3W-9000-R1N, B3W-9000-Y1N, B3W-9000-RG2N
Toggle Switch 3/4 Poles	<a href="#">Toggle Switch</a>	100SP1T2B3M2QEH
Light-Toggle Switch	<a href="#">Light Toggle Switch</a>	G12JPCF
Code Wheel+ Optical Encoder	<a href="#">Encoder+ Code Wheel</a>	HEDB-9100-C12
Fader	<a href="#">Bourns PTA</a>	PTA3043-2015CPB103,PTA6043-2015CPB103
Long Fader	<a href="#">ALPS RS series</a>	RSA0N11S9A0K
Long Fader 2	<a href="#">Bourns PTB</a>	PTB0143-2010BPB103
Light-Fader	<a href="#">Bourns PTL</a>	PTL30-10G1-103B2, PTL30-15R1-104B2, PTL60-10G1-103B2, PTL60-15R1-104B2
Motor Fader	<a href="#">Alps MotorFader 60mm</a>	RS60N11M9A0F
Rotary Pot	<a href="#">ALPS Rotary pot</a>	RK09L1140A66
SD Card Socket	<a href="#">SD Socket</a>	SDCRD-GM-271
OLED 256x64px 3,12"	<a href="#">Newhaven OLED</a>	NHD-3.12-25664UMY3
OLED 256x64px 3,2 "	<a href="#">3.2" OLED</a>	ER-OLEDM032

Designation	Datasheet Link	Reference
OLED 128x64px 0,96"	<a href="#">0.96" OLED</a>	ER-OLEDM0.96
CLCD 20x4	<a href="#">20x4 LCD</a>	ERM2004
CLCD 40x4	<a href="#">40x4 LCD</a>	ERM4004
8x8 Monochrome DotMatrix	<a href="#">8x8 Dotmatrix</a>	TC15-11EWA
8x8 RGB DotMatrix	<a href="#">8x8 RGB Dotmatrix</a>	YSM-2388CRGBC
3 Digits Numeric Display	<a href="#">3 Digits Numeric Display</a>	BA56-12SRWA
Silicon 4x4 Button Matrix 5mm	<a href="#">Silicon 4x4 5mm Button Matrix</a>	/
Silicon 4x4 Button Matrix 3mm	<a href="#">Silicon 4x4 3mm Button Matrix</a>	/
Joystick 1	<a href="#">Joystick 1</a>	/
Joystick 2	<a href="#">Joystick 2</a>	/
Force Touch Sensor	<a href="#">Interlink FSR402</a>	34-00015
Ring Sensor	<a href="#">Interlink Ring Sensor</a>	40-24131
Linear+Force Sensor	<a href="#">Interlink linear+force sensor</a>	34-00022
Linear Touch Sensor	<a href="#">SpectraSymbol SoftPot</a>	SP-L-0100-103-ST
Circular Touch Sensor	<a href="#">SpectraSymbol SoftPot</a>	SP-R-0046-103-ST

## Buy Places

- [Mouser](#)
- [Buydisplay](#)
- [Interlink Force Sensors @ Digikey](#)
- [Interlink Ring Sensor @ Roboshop](#)
- [SpectraSymbol Circular Tactile Sensor @Adafruit](#)
- [SpectraSymbol Linear Tactile Sensor @Adafruit](#)

## Software / Firmware

- [JUCE Ressources](#)

A **GUI** will be developed with JUCE Library to make your **MIDI mapping** upon your custom control interface and make your **custom infos display on OLED / CLCDs / LEDs Matrixes**. Upon a list of **Pre-made functions**, you would be able to connect a **MIDI mapping** to Controller / Sequencer / Other MIDIbox apps functions into the JUCE GUI

**TODO:** Make a inkscape sketch For the JUCE GUI then remake it with **Projucer**

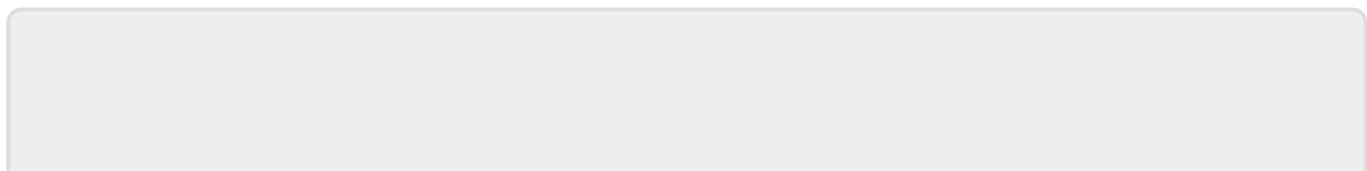

From:

<https://midibox.org/dokuwiki/> - **MIDIbox**

Permanent link:

<https://midibox.org/dokuwiki/doku.php?id=mb-modulbox-ng&rev=1470803383>



Last update: **2016/08/10 04:29**