

MB-SIDR8TR

This is a project built around making a MidiBox SID in a 3U rackmount case using the MB-6582 mainboard. This is a **huge** work in progress however feel free to contribute!

Status

2011-10-14

Approached the control surface from an entirely new angle but putting the shift registers directly on the boards. This branches away from the MB-6582 design but can be configured with minimal code modifications, and makes the design of the control surface, and various parts, easier. Wiring it all up is also easier and now involves largely DIL headers. The board that is further along is currently the LED matrix, which is actually two boards (the LED matrix board itself plus a daughterboard housing the shift registers that is mounted behind it).

2011-09-11

Added jumpers to the LED matrix board to make it a bit more flexible since you can choose whether or not to share 2 pins from the JD8 header. The board would still require using a button-matrix, however. This was to make the board more compatible for other MidiBoxers (I plan on using the same wiring as the MB-6582 control surface).

2011-09-06

Back at it again. I set this project down for a while to work on my band's debut album (which used more the NES than the SID). I also was feeling overwhelmed with designing the control surface stuff. But I'm back it! Worked on the LCD module and ended up trying out a 2x20 setup instead which makes the LCD control board smaller by directly mounting the LCD itself to the front panel via blind threaded screws on the back. That's the idea, anyway. [This](#) post has some good thoughts on using blind screw-holes for mounting the LCD to the front panel.

Also received some good advice in [this](#) post for using a line-drive to provide balanced outs. Thinking of using that for the passive mixer out although doing that for all inputs may require some further thought since it takes up a lot of space and pushes the limits of Eagle Standard (could modularize it though).

2011-05-12

Finished the wiring for the LCD module, though it's somewhat unoptimized (lots of vias). Thinking of doing it again but with a smaller wire size. The other modules should be a bit easier.

2011-03-31

Panel design is nearing completion, though there are a few ideas I still need to try such as some of the ones in [this](#) post. From that same post, I learned that using set screws on the back of the panel can be used to secure the panel for some of the additional screws I was going to add to the CS boards for rigidity. That means I need to go with at least a 3mm panel though, so I may need to put in a cut-out for the LCD panel on the back.

2011-03-26

Updated the LED Matrix board to have an option for both SMD and through-hole

2011-03-21

BZZT! Setbacks. Turns out I over measured the available inside space of the 3U chassis so I had to reduce the vertical height of my control surface, which mucked things up a bit. I think I have things basically fixed, although things are a bit asymmetric vertically now which sort of bugs me. I can likely resolve that by using a smaller LCD panel - either a 4x20 with a smaller overall size or a 2x20 with a standard size. I will miss the cool progress indicator for the 4x20 but the 2x20 gives me way more colors to choose from, including cool inverted colors, oooh! See [this](#) forum post for more info.

I think I've settled on the spacers to use. I am going with male/female spacers 11/32" (8.75mm) in length, which will be a bit less than was used for the MB-6582, meaning the buttons may stick out a bit more, but otherwise it will allow me to use a 2mm or 2.5mm front-panel. Thanks to nebula for the male/female spacers. See [this](#) forum post for more info. One thing I didn't account for was the LCD, and that may make things a little tight.

2011-03-17)

All of the boards with knobs have been designed, leaving only the LCD panel board and the SID selector board. I am behind on updating the wiki but will do so probably once I finish all the boards since I don't want to have to re-upload revisions of the front panel or control surface PCBs as I refine the measurements and things. If anyone wants to see the work in progress, send me a [PM](#).

Parts

- [3U Chassis](#) - Jameco Part # 132848
- Encoders: I am planning on using similar ones to the MB-6852. You can find Eagle parts for these at the MidiBox [parts](#) library.

Panels

This is the current iteration of the panel, though alternative designs can be found on the forum [post](#)

relating to this project as well.



[frontpanel-rev2.zip](#)

Boards

Here are the collection of boards required to populate the control surface. Since a single-board solution would be quite expensive (starting with the full version of EagleCAD), the design is more similar to the standard C64-based control surface in that various parts of the control surface can be populated using smaller boards.

Originally, I had planned on using the same wiring as the MB-6582. I have since moved away from this and, instead, am using standard shift registers mounted on the control surface boards themselves. This allows one to use the MB-6582 board if desired (via the J8/J9 headers just like a normal CORE); or to use a modular approach, as well as anything in between. Wiring all the parts together is now MUCH easier since I am just using DIL headers through all boards.

The downside is the firmware will need to be modified and the order that the components are wired matters. Thus, for folks only wanting to use some of the boards in their own designs, they may have to make their own firmware. It's very very easy to do, however - it's all well documented in the MBSID source code.

Control Surface Header Pinout

Note: Headers will be mounted on the bottom of most boards such that the cabling will be behind the control surface parts.

J9	J8
DIN	DOUT
GND	NC
5V	NC
SI	SO
SC	SC
RC	RC

Equivalent Symbols

J9: 74HC165

Pin	ucapps	Eagle	Chip Pin
SI	QR	QH	9
SC	CLK	CLK	2
RC	LD	SH/LD	1

J8: 74HC595

Pin	ucapps	Eagle	Chip Pin
SO	SER	SER	14
SC	SCLK	SCK	11
RC	RCLK	RCK	12

LED Matrix

I have designed this a few times and finally settled on using a baseboard that houses the LEDs and buttons, and using a daughterboard to house the shift-registers and things. This should also allow the MB-6582 button matrix via another daughter-card.

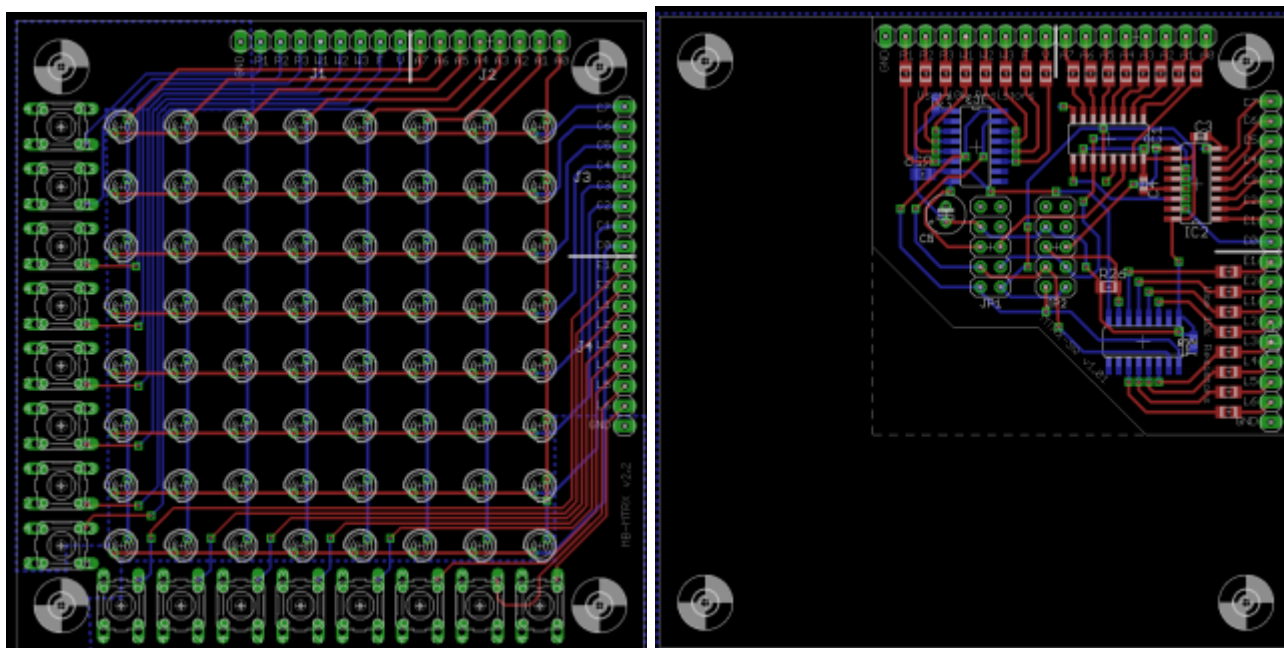

A [Bulk Order](#) is being organized if you are interested in obtaining your own board at a better price than doing a single board one-off. If you want to know more about the latest happenings, check out [this](#) forum post.

Parts List

Part	Description	Mouser	Farnell
S1-S16	6mm x 6mm Tactile Switch		
D1-D16	SMD Switching Diode	1N4148W-V-GS08	13114 1n4148w-v-gs08 S e 5480397067 1469425
LED1-LED64	3mm LED		
JD5, JD6, JD8	SIL Pin Header		

Note that other SMD diodes may work, such as Mini-MELF.

AudioBus

Since I wanted to use external filters and have both a front and rear mixed out, I thought it best to create my own passive mixer board. It combines the passive mixer idea from the MB-6582 with the CMoy amp. I opted to go with the CMoy design because it is easy, effective, and can function both as a headphone and pre-amp.

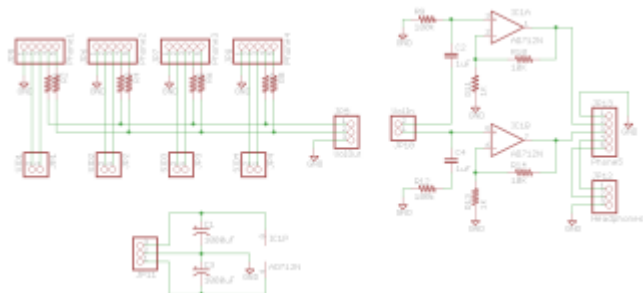

I am still working on the board design but once it is complete, I will post it here. The board may end up being two boards depending on how bulky it is. I wanted to use PCB mount audio jacks (basically Neutriks from the MB-6582 and Sammich synths) and was planning on using the audio jacks themselves to suspend the board up since I was going to mount my audio jacks probably towards the center of the rear panel (to leave room down below for other boards). I also have not figured out if cable distance is going to be an issue or anything like that.

Power

The power board supplies +/- 12V, +9V and +5V. +12V might be able to be used for a SID-6581 but the board is really optimized around supplying +9V (in other words, 8580/6852 SIDs). This board is based off northernlightx's Complete PSU with a few modifications. The +/- 12V is for adding AOUT modules (namely for SSM 2044 filters). **NOTE** Be sure to use at least one fuse! Putting one on for the main supply before going to the transformer is a very very good idea!

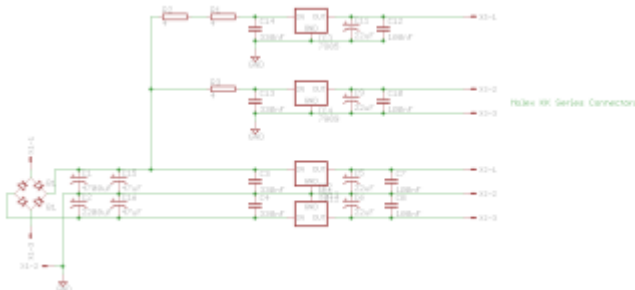
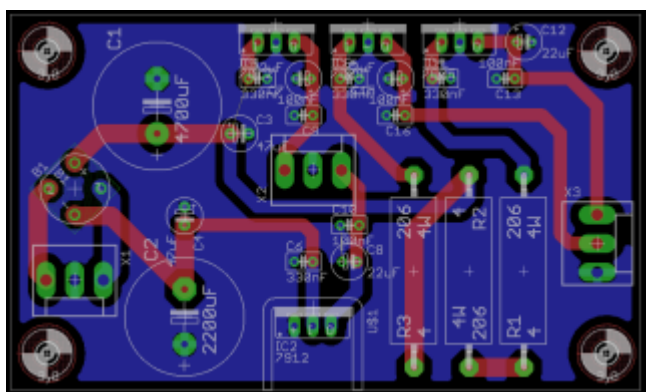

[eagle-rev2.zip](#)

pwr-

As an alternative, there is a wonderful discussion on the forums about using a modern switching the supply. The idea being that modern switching supplies switch at a frequency far higher than most practical uses of the SID (particularly when given it's noise floor). I have not made up my mind about it yet, however, because the supply discussed switches at 132kHz, which is out of the range of human

hearing, but not out of the range of some modern samplers. The only time that I can think would be of significance is when sampling at a grossly high rate (such as 192kHz) and manipulating the audio enough to lower the noise floor to audible levels (say by slowing the audio down, and thus the sampling rate, to a large amount).

That's a pretty pathological case so, for all intents and purposes, the Mean Well supplies mentioned on the forum post (such as [this](#)) should be well suitable for the SIDR8TR. I have not decided on what I am going to do yet since the switching supplies are smaller, though linear supplies are more fun :) I think I will compromise and go with a switching supply but use some additional filtering caps, most notably tantalum and perhaps ceramic caps. I don't have a way of testing how much they attenuate the noise but poking around online does show that tantalum caps seem like they would do the trick. I was mostly thinking of adding them as peace of mind :)

Useful Links

- http://midibox.org/forums/topic/15235-custom-power-supply-for-mb6582/page__st__20

Parts List

Part	Description	Allied Part No
C1	4700uF Electrolytic Capacitor	613-0203
C2	2200uF Electrolytic Capacitor	613-0201
C3, C4	47uF Electrolytic Capacitor	613-0112
C5, C6, C11, C14	330nF Ceramic Capacitor	507-0238
C7, C8, C12, C15	22uF Electrolytic Capacitor	613-0712
C9, C10, C13, C16	100nF Ceramic Capacitor	507-0211
R1, R2, R3	4 Ohm, 5 Watt Power Resistor	296-5275
IC1	7812 Voltage Regulator	568-0489
IC2	7912 Voltage Regulator	935-3055
IC3	7809 Voltage Regulator	568-0960
IC4	7805 Voltage Regulator	568-0488
B1	Rectifier (1.5A)	935-6268
X1, X2, X3	KK-156 Molex Headers	863-0328
9x	Crimp Pins	863-0435
3x	Pin housing	863-0414
1-4x	TO-220 Heatsink	619-0127
Transformer	24VCT / 50VA	967-7285
Crimp Connectors	(For Transformer	??
Fuse Holder		Radio Shack

Props

Thanks to TK, Wilba, SmashTV, and nLS for their help, inventions, and support. Without them, this would not have been possible!

From:

<https://midibox.org/dokuwiki/> - **MIDIbox**

Permanent link:

<https://midibox.org/dokuwiki/doku.php?id=mb-sidr8tr:start&rev=1321111816>

Last update: **2011/11/12 15:30**

