

OpenPAD Codeblock

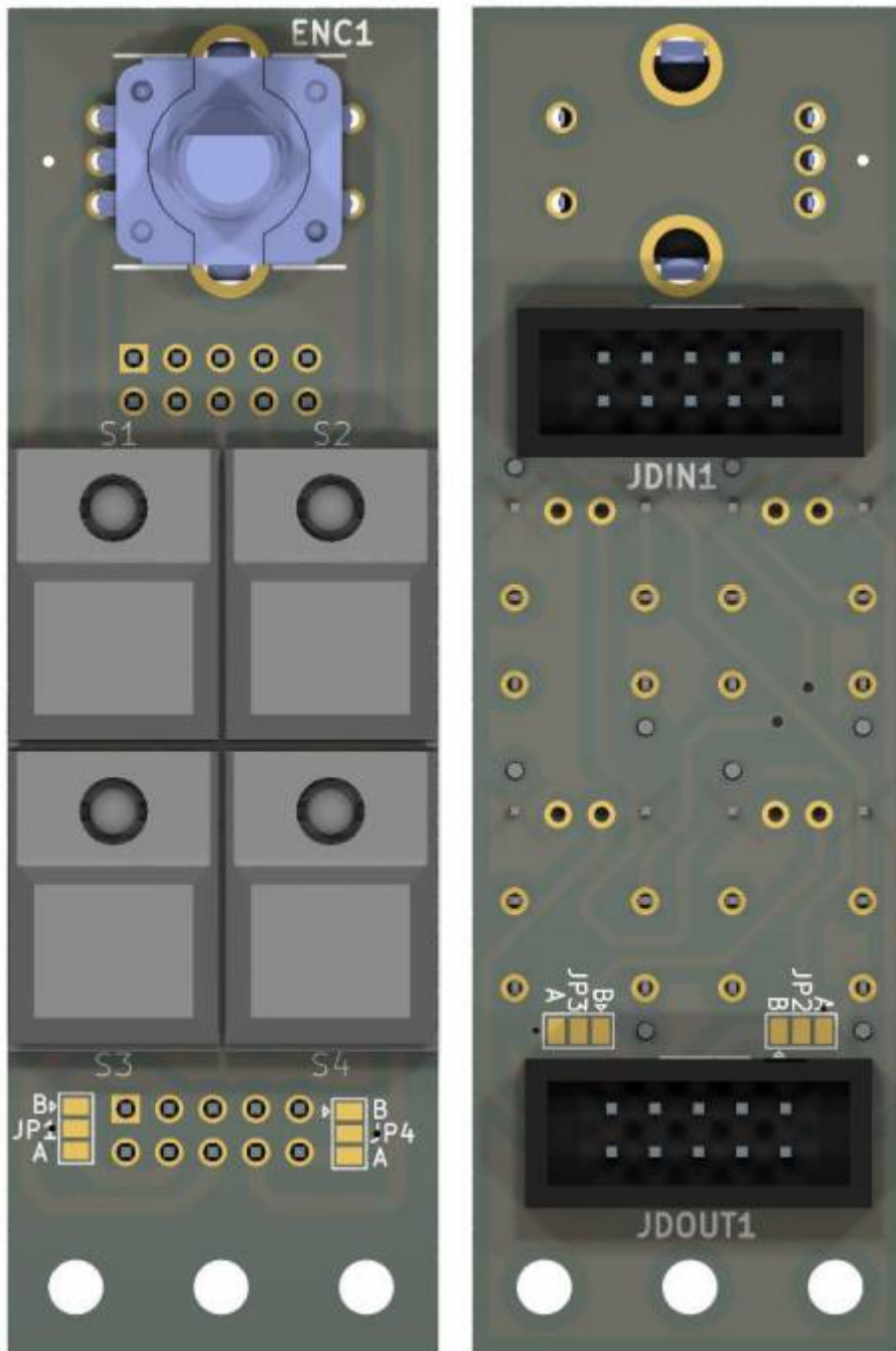

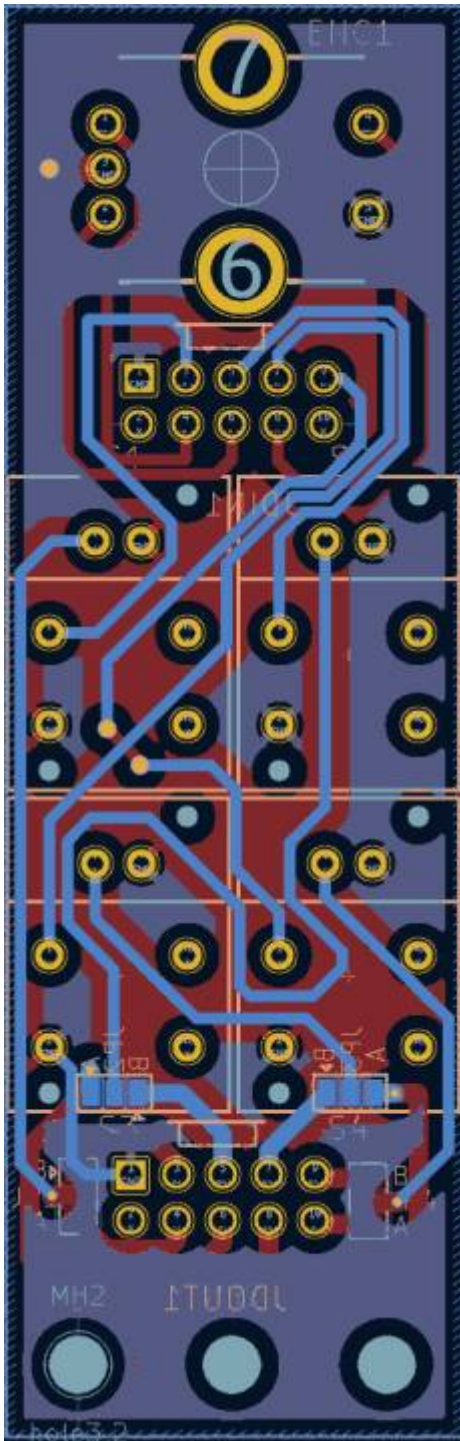

this is one essential part for my [OpenPAD](#)
it handles the Menu and the Buttons...

Schematic

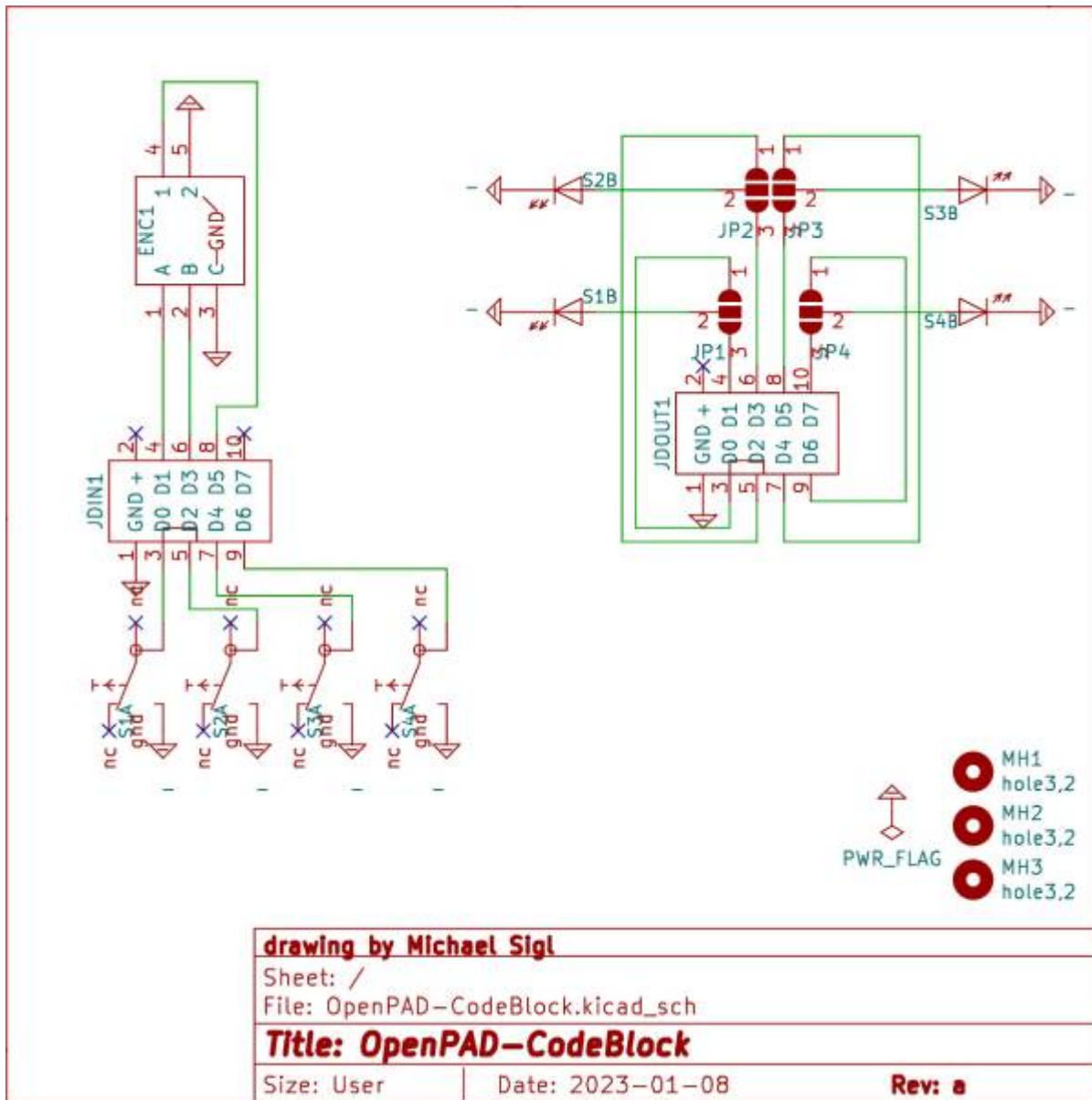

Building and BOM

100 THT, and handsolder
This PCB is needet 2x for [OpenPAD](#)

BOM

qty	reference	value	mouser
1	ENC	PEC11R-4015F-S0024	652-PEC11R-4015F-S24
2	JDIN1, JDOUT1,	Pin-Header-Shroudet-2x5-THT-DIN	517-30310-6002

Order-List

copy following list into this [mouser.com-Link](#)

652-PEC11R-4015F-S24|1

Order from Reichelt:

5x [Button](#)

2x [PinHeader 2x5Pin Female](#)

Order from Midiphy:

1x Knob Set [DK16-190V3 knob](#)

To Do

waiting for the Prototype

Community users working on it

- [Phatline](#) = PCB & Schematic, UI-Programming, Documentation...

Just let a Private message on the forum to user already involved.

or join the forum: [Triggermatrix 5](#)

From:

<https://midibox.org/dokuwiki/> - **MIDIbox**

Permanent link:

<https://midibox.org/dokuwiki/doku.php?id=openpad-codeblock&rev=1673220382>

Last update: **2023/01/08 23:26**

